

SATEL

Mission-Critical Connectivity

SATEL-EASy Pro+
radio modem
user guide
version 1.7

IMPORTANT NOTICE

All rights to this manual are owned solely by SATEL Oy (referred to in this user guide as SATEL). All rights reserved. The copying of this manual (without the written permission from the owner) by printing, copying, recording or by any other means, or the full or partial translation of the manual to any other language, including all programming languages, using any electrical, mechanical, magnetic, optical, manual or other methods or devices is forbidden.

SATEL reserves the right to change the technical specifications or functions of its products, or to discontinue the manufacture of any of its products or to discontinue the support of any of its products, without any written announcement and urges its customers to ensure, that the information at their disposal is valid.

SATEL software and programs are delivered "as is". The manufacturer does not grant any kind of warranty including guarantees on suitability and applicability to a certain application. Under no circumstances is the manufacturer or the developer of a program responsible for any possible damages caused by the use of a program. The names of the programs as well as all copyrights relating to the programs are the sole property of SATEL. Any transfer, licensing to a third party, leasing, renting, transportation, copying, editing, translating, modifying into another programming language or reverse engineering for any intent is forbidden without the written consent of SATEL.

SATEL PRODUCTS HAVE NOT BEEN DESIGNED, INTENDED NOR INSPECTED TO BE USED IN ANY LIFE SUPPORT RELATED DEVICE OR SYSTEM RELATED FUNCTION NOR AS A PART OF ANY OTHER CRITICAL SYSTEM AND ARE GRANTED NO FUNCTIONAL WARRANTY IF THEY ARE USED IN ANY OF THE APPLICATIONS MENTIONED.

Salo, FINLAND 2025

RESTRICTIONS ON USE

SATEL-EASy Pro+ radio modems have been designed to operate on frequency ranges, the exact use of which differs from one region and/or country to another. The user of a radio modem must take care that the said device is not operated without the permission of the local authorities on frequencies other than those specifically reserved and intended for use without a specific permit.

The allowed max output power depends on the local authority requirements.

SATEL-EASy Pro+ is allowed to be used in the following countries, either on licence free channels or on channels where the operation requires a licence. More detailed information is available at the local frequency management authority.

Countries: AT, AU, BE, BG, CA, CH, CY, CZ, DE, DK, EE, ES, FI, FR, GB, GR, HU, IE, IS, IT, LT, LU, LV, MT, NL, NO, PL, PT, RO, RU, SE, SK and US.

WARNING – RF Exposure! To comply with RF exposure compliance requirements in Europe, USA and Canada maximum antenna gain is 14 dBi and a separation distance listed in a table below must be maintained between the antenna of this device and all persons. This device must not be co-located or operating in conjunction with any other antenna or transmitter.

Antenna gain [dBi]	Minimum distance [m]
0	1.4
4	2.2
6	2.7
8	3.4
10	4.2
12	5.3
14	6.7

WARNING!

Users of radio modems in North America should be aware, that due to the allocation of the frequency band 406.0 – 406.1 MHz for government use only, the use of radio modem on this frequency band without a proper permit is strictly forbidden.

In USA and Canada this product is certified to use frequencies 406.1 – 430 MHz and 450 – 470 MHz. Using this device in USA or Canada outside these frequencies is prohibited.

This device complies with part 15 of the FCC rules. Operation is subject to the following two conditions: (1) This device may not cause harmful interference, and (2) this device must accept any interference received, including interference that may cause undesired operation.

NOTE:

This equipment has been tested and found to comply with the limits for a Class B digital device, pursuant to part 15 of the FCC Rules. These limits are designed to provide reasonable protection against harmful interference in a residential installation. This equipment generates, uses and can radiate radio frequency energy and, if not installed and used in accordance with the instructions, may cause harmful interference to radio communications. However, there is no guarantee that interference will not occur in a particular installation. If this equipment does cause harmful interference to radio or television reception, which can be determined by turning the equipment off and on, the user is encouraged to try to correct the interference by one or more of the following measures:

- Reorient or relocate the receiving antenna.
- Increase the separation between the equipment and receiver.
- Connect the equipment into an outlet on a circuit different from that to which the receiver is connected.
- Consult the dealer or an experienced radio / TV technician for help.

PRODUCT CONFORMITY

SATEL Oy hereby declares that SATEL-EASy Pro+ radio modem is in compliance with the essential requirements (radio performance, electromagnetic compatibility and electrical safety) and other relevant provisions of Directive 2014/53/EU. Therefore, the equipment is labelled with the following CE-marking.



WARRANTY AND SAFETY INSTRUCTIONS

Read these safety instructions carefully before using the product:

- Warranty will be void, if the product is used in any way that is in contradiction with the instructions given in this manual, or if the radio modem housing has been opened or tampered with.
- The radio modem is only to be operated at frequencies allocated by local authorities, and without exceeding the given maximum allowed output power ratings. SATEL and its distributors are not responsible, if any products manufactured by it are used in unlawful ways.
- The devices mentioned in this manual are to be used only according to the instructions described in this manual. Faultless and safe operation of the devices can be guaranteed only if the transport, storage, operation and handling of the devices are appropriate. This also applies to the maintenance of the products.
- To prevent damage both the radio modem and any terminal devices must always be switched OFF before connecting or disconnecting the serial connection cable. It should be ascertained that different devices used have the same ground potential. Before connecting any power cables, the output voltage of the power supply should be checked.
- If the device uses an outdoor antenna, the antenna cable jacket must be grounded.

TABLE OF CONTENTS

IMPORTANT NOTICE.....	1
RESTRICTIONS ON USE	2
PRODUCT CONFORMITY	4
WARRANTY AND SAFETY INSTRUCTIONS	4
TABLE OF CONTENTS.....	5
PRODUCT INTRODUCTION.....	9
1. SATEL-EASY PRO+ TECHNICAL SPECIFICATIONS	10
1.1 Regulations.....	10
1.2 General specifications	10
1.3 Radio specifications.....	11
1.4 Data modem specifications	13
1.5 Default settings.....	13
2. SATEL-EASY PRO+ SPECIAL FEATURES	16
2.1 Call Sign.....	16
2.2 Temperature protection of RF power amplifier	16
2.3 Input voltage	19
2.4 RF-PA voltage.....	19
3. LCD USER INTERFACE.....	20
3.1 LED-indicators.....	20
3.2 Display and push buttons	20
3.2.1 LCD menu navigation	22
4. SERIAL DATA AND POWER INTERFACES	25
4.1 RS-232 interface	25
4.2 RS-485 interface.....	25
4.3 RS-422 interface	26
4.4 Port 1 wiring.....	26
4.5 Port 2 wiring.....	27
4.6 Power connector	27

5.	RF INTERFACE.....	28
5.1	Transmitter.....	28
5.2	Receiver.....	28
5.3	Encryption.....	29
5.4	Radio state.....	30
5.5	Priority RX/TX	30
5.6	Forward Error Correction.....	30
5.7	Error checking.....	31
5.7.1	SATELLINE-3AS NMS -radio compatibility mode	31
5.7.2	SATELLINE-3AS mode	31
5.8	Separate RX/TX-frequencies.....	32
5.9	Compatibility modes.....	32
5.9.1	Radio compatibility.....	32
5.9.2	Configuration by using SL commands	34
5.9.3	Settings.....	35
5.9.4	Repeater function.....	37
5.9.5	Support for Local / Remote addresses	37
6.	TRANSPARENT DATA TRANSMISSION.....	39
6.1	Serial interface, data format.....	39
6.2	Handshake lines.....	39
6.2.1	CTS-line.....	40
6.2.2	CD-line	40
6.2.3	RTS-line.....	40
6.3	Timing and delays during data transmission.....	41
6.3.1	Data buffering in the radio data modem.....	41
6.3.2	Pause length	41
6.3.3	TX delay	42
6.3.4	RX delay	42
7.	TEST MODES.....	43
7.1	Short block test.....	43
7.2	Long block test.....	43
8.	SETTINGS.....	44
9.	SL COMMANDS.....	49
9.1	Changing parameters using the SL COMMANDS.....	49
9.2	Command Mode.....	50

9.2.1	Entering to command mode.....	50
9.2.2	Return to data mode.....	50
10.	CHANNEL LIST.....	51
11.	REPEATER MODE AND ADDRESSING.....	53
11.1	Repeater.....	53
11.2	Addressing.....	54
11.2.1	Connection between two points.....	56
11.2.2	System of one base station and several substations.....	56
11.3	Using repeaters and addresses in the same system.....	57
11.3.1	System with several repeaters.....	57
11.3.2	Repeater chain using address pairs.....	58
11.3.3	Repeater chain using dual addressing.....	59
11.3.4	Redundant repeater chain.....	59
12.	MESSAGE ROUTING.....	60
12.1	Introduction to Message Routing.....	60
12.1.1	Features of Message Routing.....	61
12.1.2	Limitations of Message Routing.....	61
12.1.3	Configuration of the Message Routing.....	61
12.1.4	Configuration of the protocol in Message Routing.....	63
12.2	Detailed description of Source Routing.....	64
12.2.1	Over-hop function in Source Routing.....	65
12.2.2	Network ID.....	66
13.	NMS NETWORK MANAGEMENT SYSTEM.....	67
13.1	System components.....	67
13.2	NMS – Installation.....	67
13.1	How to add SATEL-EASy Pro+ to SATELLINE-3AS NMS network in SATEL NMS PC	68
13.2	NMS - Usage.....	68
13.3	NMS functionality.....	68
13.4	Requirements for the user system.....	69
13.5	Designing ID Systems and Networks.....	69
14.	SOFTWARE FEATURE EXTENSIONS.....	70
14.1	AES256 encryption (YD0402).....	70
14.2	SATEL NMS default config (YD0602).....	70
15.	INSTALLATION.....	71

15.1	Installation of a radio data modem	71
15.1.1	Fuse	71
15.1.2	Power supply	71
15.2	Antenna installation	72
15.2.1	Mobile equipment	72
15.2.2	Base stations	72
15.2.3	General antenna installation instructions	72
15.3	SATEL-EASy Pro+ grounding	75
15.4	Grounding cable and screws	76
16.	DESIGNING SYSTEMS	77
16.1	Factors affecting the quality and distance of the radio connection	77
16.2	Radio field strength	78
17.	CHECK LIST	79
18.	ACCESSORIES	80
18.1	RS-232 cables and adapters	80
18.2	Power cable	80
18.3	RF-cables	80
18.4	Antennas	81
18.5	Filters and lightning protectors	81
19.	APPENDIX A	82
20.	APPENDIX B	83
20.1	Transmission related delays	83
20.1.1	Transmission delays when the radio TX frequency is changed.....	83
20.1.2	Transmission delays when using a 12.5 kHz radio channel	83
20.1.3	Transmission delays using a 25 kHz radio channel	85
21.	APPENDIX C	87
21.1	Dimensions, SATEL-EASy Pro+	87
22.	VERSION HISTORY	90

PRODUCT INTRODUCTION

SATEL-EASy Pro+ is an IP67 classified UHF radio modem with a high power (35 W) transmitter, wide 70 MHz tuning range (403...473 MHz) in one hardware and selectable channel spacing. The SATEL-EASy Pro+ can offer radio speeds up to 28.8 kbps (@ 25 kHz channel spacing 16FSK, FEC ON).

SATEL-EASy Pro+ facilitates the construction of large radio networks using the built-in *Message Routing* function, which is both fully transparent to the user and can be used with most system protocols.

The radio modem also offers option of error correction, utilising the FEC-method (Forward Error Correction). FEC can be used to minimise errors caused by noisy channels.

The key features include:

- 403-473 MHz frequency range
- User selectable channel spacing 12.5 / 20 / 25 kHz
- Compatible with the widely used SATELLINE-3AS, SATELLINE-EASy and SATELLINE-3AS NMS radio modem families.
- 403-473 MHz variants are compatible also with Pacific Crest-4FSK/GMSK/FST, TRIMTALK450s radio protocols and radio protocols of RTCM 13500.1 standard.
- Half duplex radio data transfer
- Over-the-air data rate with SATELLINE-3AS compatibility option (4FSK radio modulation):
 - 9600 bps @ 12.5 kHz channel spacing (7200 bps with FEC on)
 - 9600 bps @ 20 kHz channel spacing (7200 bps with FEC on)
 - 19200 bps @ 25 kHz channel spacing (14400 bps with FEC on)Max.: 28800 kbps (@ 25 kHz channel spacing, 16FSK, FEC ON)
- Small current consumption, sleep modes
- Power level of the transmitter 1 W...35 W
- RS-232 / RS422* / RS485* serial interface at 9600...115200 bps data rates (*2 RS-port HW variant)
- LCD display and 4 push buttons
- Easy configuration, no need to use external terminal to change the basic settings
- Monitoring of the signal (RSSI) or noise level and the voltage of the power supply
- LED indicators show the status information of the operations and functions.
- Routing/repeater functions
- Error correction (FEC)
- External command language (SL commands)

Please visit SATEL WEB pages for suitable software tools:

<https://www.satel.com/products/software/software-product-compatibility-table/>

Additional information regarding SW tools can be found from

<https://www.satel.com/products/software/>

1. SATEL-EASy Pro+ TECHNICAL SPECIFICATIONS

1.1 Regulations

SATEL-EASy Pro+ complies with the following international standards:

- EN 300 113 (RF-requirements)
- EN 301 489 (EMC-requirements)
- EN 62368-1 (Safety Standard)
- FCC CFR47 Part 90 (Private Land Mobile Radio Service)

1.2 General specifications

Parameter	Value	Unit	Remark
Operating DC Voltage Input Range	+9...+30	Vdc	In addition EN 62368 requirement +7.65 ... +36 VDC
Temperature Range	-20... +55	°C	Functional (complies with standards)
	-40... +85	°C	Storage
TX Power Consumption, $T_a = +20^{\circ}\text{C} \dots +25^{\circ}\text{C}$	typ. 9...10	W	RF _{out} = +30.0 dBm (1 W), 403-473 MHz, V _{in} = +9...+30 VDC
	typ. 14...20	W	RF _{out} = +37.0 dBm (5 W), 403-473 MHz, V _{in} = +9...+30 VDC
	typ. 27...33	W	RF _{out} = +40.0 dBm (10 W), 403-473 MHz, V _{in} = +9...+30 VDC
	typ. 60...72	W	RF _{out} = +44.0 dBm (25 W), 403-473 MHz, V _{in} = +9...+30 VDC
	typ. 84...97	W	RF _{out} = +45.4 dBm (35 W), 403-473 MHz, V _{in} = +9...+30 VDC
RX Power Consumption, $T_a = +20^{\circ}\text{C} \dots +25^{\circ}\text{C}$	typ. 1.8...2.3	W	403-473 MHz, V _{in} = +9...+30 VDC
Power Consumption in Sleep mode (SL+S=8) $T_a = +20^{\circ}\text{C} \dots +25^{\circ}\text{C}$	typ. 0.9...1.4	W	403-473 MHz, V _{in} = +9...+30 VDC
Inrush Current, DC Voltage Turned ON	< 27	A	
Vibration	<5g		Sine sweep parameters Acc. to: ISO 9022-3:2015 method 36 Severity levels 6 and 9 5 Hz -2000 Hz. Electrical or mechanical deteriorations were not observed.
ESD ¹	±8	kV	Air discharge Acc. to EN 61000-4-2. Display, touch panel
	±4	kV	Contact discharge Acc. to EN 61000-4-2. Connector, Screws, bottom, top, left, and right sides.
	±8	kV	Connectors, signal lines.

Weight	1.4	kg	
IP Classification	IP67		Equivalent NEMA6
Dimensions	180.4 x 138.4 x 70.9	mm	

¹ Measured under normal ambient conditions, $T_A = +20^{\circ}\text{C} \dots +25^{\circ}\text{C}$. When the device is used in different environment, the results may change significantly. It is recommended to use external ESD protection in demanding conditions.

1.3 Radio specifications

Test conditions: VDC = +12V, $T_A = +20^{\circ}\text{C} \dots +25^{\circ}\text{C}$ unless otherwise noted.

Radio Parameter	Receiver	Transmitter	Unit	Remark
Frequency Range ^{2,3}	403 - 473		MHz	
Tuning Range	70		MHz	
Channel Bandwidth	12.5, 25		kHz	
Channel Spacing	12.5, 20, 25		kHz	Programmable (uses 12.5 kHz channel bandwidth @ 20 kHz channel spacing)
Min. RF Freq. Step	6.25		kHz	10 kHz @ 20 kHz channel spacing
Frequency Stability	± 0.5		ppm	-40...+85°C (Referenced to +25°C)
Maximum Receiver Input Power without Damage	+3		dBm	
Max. Receiver Input Power without Transmission Errors	-10		dBm	4FSK, 25 kHz, FEC ON
Sensitivity ¹ BER = 10^{-2}	typ. -112		dBm	4FSK, 25 kHz, FEC ON
	typ. -114		dBm	4FSK, 12.5 kHz, FEC ON
	typ. -110		dBm	8FSK, 25 kHz, FEC ON
	typ. -112		dBm	8FSK, 12.5 kHz, FEC ON
	typ. -102		dBm	16FSK, 25 kHz, FEC ON
	typ. -104		dBm	16FSK, 12.5 kHz, FEC ON
Blocking ¹ BER = 10^{-2}	>-20		dBm	4FSK, 25 kHz, FEC ON
	>-20		dBm	4FSK, 12.5 kHz, FEC ON
	>-20		dBm	8FSK, 25 kHz, FEC ON
	>-20		dBm	8FSK, 12.5 kHz, FEC ON
	typ.-31		dBm	16FSK, 25 kHz, FEC ON
	>-20		dBm	16FSK, 12.5 kHz, FEC ON
Intermodulation Response Rejection ¹ BER = 10^{-2}	typ. -36		dBm	4FSK, 25 kHz, FEC ON
	typ. -38		dBm	4FSK, 12.5 kHz, FEC ON
	typ. -37		dBm	8FSK, 25 kHz, FEC ON
	typ. -36		dBm	8FSK, 12.5 kHz, FEC ON
	typ. -45		dBm	16FSK, 25 kHz, FEC ON
	typ. -37		dBm	16FSK, 12.5 kHz, FEC ON

CO-Channel Rejection ¹ BER = 10 ⁻²	typ. 9		dBm	4FSK, 25 kHz, FEC ON
	typ. 9		dBm	4FSK, 12.5 kHz, FEC ON
	typ. 11		dBm	8FSK, 25 kHz, FEC ON
	typ. 12		dBm	8FSK, 12.5 kHz, FEC ON
	typ. 23		dBm	16FSK, 25 kHz, FEC ON
	typ. 21		dBm	16FSK, 12.5 kHz, FEC ON
Adjacent Channel Selectivity ¹ BER = 10 ⁻²	typ. -32		dBm	4FSK, 25 kHz, FEC ON
	typ. -34		dBm	4FSK, 12.5 kHz, FEC ON
	typ. -33		dBm	8FSK, 25 kHz, FEC ON
	typ. -33		dBm	8FSK, 12.5 kHz, FEC ON
	typ. -43		dBm	16FSK, 25 kHz, FEC ON
	typ. -33		dBm	16FSK, 12.5 kHz, FEC ON
Spurious Rejection	>-34		dBm	4FSK, 12.5 and 25 kHz, FEC ON
Transmitter Power		+30.0 (1W) +37.0 (5W) +40.0 (10W) +44.0 (25W) +45.4 (35W)	dBm	
Communication Mode	Half-Duplex			
Frequency Change Time	typ. 20		ms	
Adjacent Channel Power		<-60	dBc	TX-mode, 12.5 and 25 kHz. Acc. to EN 300 113
Carrier Power Stability		<±1.5	dB	During transmission
Immunity Test	20		V/m	Acc. to EN 61000-4-3 80 - 1000 MHz
	3		V/m	Acc. to EN 61000-4-3 1000 - 6000 MHz

¹ According to EN 300 113 measurement setup.

² Firmware rejects 405.925...406.176 MHz frequencies. The frequency band is reserved internationally for emergency transmitters as specified by FCC reference FCC 04-75

³ In USA and Canada this product is certified to use frequencies 406.1 – 430 MHz and 450 – 470 MHz. Using this device in USA or Canada outside these frequencies is prohibited.

1.4 Data modem specifications

Parameter	Modem	Unit	Remark
Timing	RS-232		
Port1 Electrical Interface	RS-232		Port is always RS-232
Port2 Electrical Interface	RS-232/RS-422/RS485		User selectable
Data Speed of Port1 and Port2	9600, 19200, 38400, 57600, 115200	bps	
Data Bits	8N1, 8N2, 8E1, 8E2, 8O1, 8O2, 7E1, 7E2, 7O1, 7O2		
Modulation (On-Air Bit Rate)			
4FSK ("SATELLINE-3AS" compatibility mode, FEC OFF / FEC ON)	19200 / 14400	bps	25 kHz
	9600 / 7200	bps	12.5 kHz
8FSK (FEC OFF / FEC ON)	28800 / 19200	bps	25 kHz
	14400 / 9600	bps	12.5 kHz
16FSK (FEC ON)	28800	bps	25 kHz
	14400	bps	12.5 kHz
GMSK	4800	bps	12.5 kHz, 25 kHz
	8000	bps	12.5 kHz
	9600	bps	25 kHz
	16000	bps	25 kHz
Air Interface Encryption	AES128, AES256		AES256 as DRM option
Data Formats	Asynchronous		

1.5 Default settings

SATEL-EASy Pro+ is shipped with the following default settings (unless otherwise specifically agreed):

DEFAULT VALUES OF THE ADJUSTABLE SETTINGS (user can change settings later on)		
Setting	Default value	Range
Radio frequency		
Operating TX frequency	438.000 MHz	Range: 403 – 473 MHz
Operating RX frequency	438.000 MHz	Range: 403 – 473 MHz
Reference Frequency	438.000 MHz	Range: 403 – 473 MHz
Channel Spacing	12.5 kHz	Range: 12.5, 20 or 25 kHz
Radio settings		
Tx Power	+45,4 dBm (35W)	Range: +30.0 dBm (1 W), +37.0 dBm (5 W), +40.0 dBm (10 W), +44.0 dBm (25 W), +45.4 dBm (35 W) Depending on regional code 25W or 35W

Signal threshold	-115 dBm	-80 ... -118 dBm
Tx-Start Delay	0 ms	0-65535 ms
Radio Compatibility	SATELLINE-3AS	See section 6.9, Compatibility modes
Encryption*	OFF	ON/OFF
Addressing		
RX Address	OFF	ON/OFF
TX Address	OFF	ON/OFF
RX addressing to RS port	OFF	ON/OFF
TX address auto switch	OFF	ON/OFF
Serial port 1		
Port 1 function	Data	Options: OFF**/Diagnostics (NMS)/Data
Interface	RS-232	Fixed
Data speed	115200 bps	9600, 19200, 38400, 57600, 115200 bps
Data bits	8	7, 8
Parity bits	None	None, Even, Odd
Stop bits	1	1, 2
Serial port 2 (Order option: EASy Pro+ 2P)		
Port 2 function	NMS	Data, NMS, OFF
Interface	RS-232	User selectable: RS-232, RS-422, RS-485
Data speed	115200 bps	9600, 19200, 38400, 57600, 115200 bps
Data bits	8	7, 8
Parity bits	None	None, Even, Odd
Stop bits	1	1, 2
Handshaking		
CTS	Clear to send	Clear to send, TX buffer state
CD	RSSI threshold	RSSI- threshold, Data on channel, Always ON
RTS	Ignored	Ignored, Flow Control
Pause length, Port1	3 bytes	3 ... 255 bytes
Pause length, Port2 (Order option: EASy Pro+ 2P)	5 bytes	3 ... 255 bytes
Additional setup		
Error correction	OFF	ON/OFF
Error check	OFF	OFF/CRC-8 Partial/CRC-8 Full/CRC-16 Full
Repeater	OFF	ON/OFF
SL-commands	ON	ON/OFF
Priority	TX	RX/TX
Routing	OFF	ON/OFF
Tests	OFF	ON/OFF
Role	Advanced - Slave	

*) Models with and without encryption support are available. See the list of the products at www.satel.com/products

**) If port 1 is set to OFF in one port model or if both ports are set to OFF in two serial interface model, port 1 (RS232) is set for data regardless of the setting.

When creating a test connection, you can use Windows™ based SATEL NETCO DEVICE (available from SATEL website, www.satel.com), HyperTerminal (which is included in most the Windows™ based operating system packages), or almost any other terminal program.

Basic settings for the serial port of the host computer, when using a terminal program to communicate with SATEL radio modems, are as follows: “COM1, 115200 bps, 8-bit data, none parity, 1 stop bit”.

If the serial port designated as COM1 in the host computer is reserved, any other free serial port in the host computer can be used (with the settings listed).

Note: If you want to change the settings of a radio modem using the *Programming Mode* of the radio modem with the help of an external terminal, the data speed of the terminal must be 38400 bps.

2. SATEL-EASy Pro+ SPECIAL FEATURES

2.1 Call Sign

SATEL-EASy Pro+ has a CALL SIGN identifier -feature required in some countries. A call sign can be formally assigned by a government agency, informally adopted by individuals or organizations, or even cryptographically encoded to disguise identity of a station.

A call sign is an FCC (in US) or other regulatory authority assigned identifier that is issued along with the license for operating a radio modem. This field is for entering your call sign. The modem automatically broadcasts the specified call sign periodically. If this field is empty, there is no call sign information.

Call sign setup can be changed via SL command or NETCO DEVICE software. Call sign has three (3) different setups. With **Call Sign Mode** you can set Morse code transmission ON or OFF. **Call Sign ID** defines which Morse code will be transmitted. Only capital letters and numbers are allowed. If the digits are wrong kind, there will be message: *Value error*. Small letters will be converted to capital letters automatically. If **Call Sign ID** field remains empty, the Call Sign transmission will not be activated. **Call Sign Timer** is the transmission delay of Morse codes. Minimum and default transmission time is 15 minutes.

During Call sign transmission the CTS-line of the modem is not in active state. This is to inform terminal equipment that the modem is not ready to neither receive data from serial port nor forward it. The modem deletes all data (also SL commands), which has arrived to serial port during call sign transmission. Call sign transmission lasts 1-4 seconds depending on the number of digits.

2.2 Temperature protection of RF power amplifier

RF power amplifier is protected against overheating. The power of transmitter is decreased and increased step by step if the inner temperature exceeds certain levels as shown below.

Parameter	Temperature
Temperature Limit 1	+70 °C
Temperature Limit 2	+75 °C
Temperature Limit 3	+80 °C
Temperature Limit 4	+85 °C
Temperature Limit 5	+90 °C

Increasing Temperature		Decreasing Temperature	
Parameter	RF Output Power	Parameter	RF Output Power
Temperature Limit 2	+44 dBm (25 W)	Temperature Limit 4	+37 dBm (5 W)
Temperature Limit 3	+40 dBm (10 W)	Temperature Limit 3	+40 dBm (10 W)
Temperature Limit 4	+37 dBm (5 W)	Temperature Limit 2	+44 dBm (25 W)
Temperature Limit 5	+30 dBm (1 W)	Temperature Limit 1	+45.4 dBm (35 W)

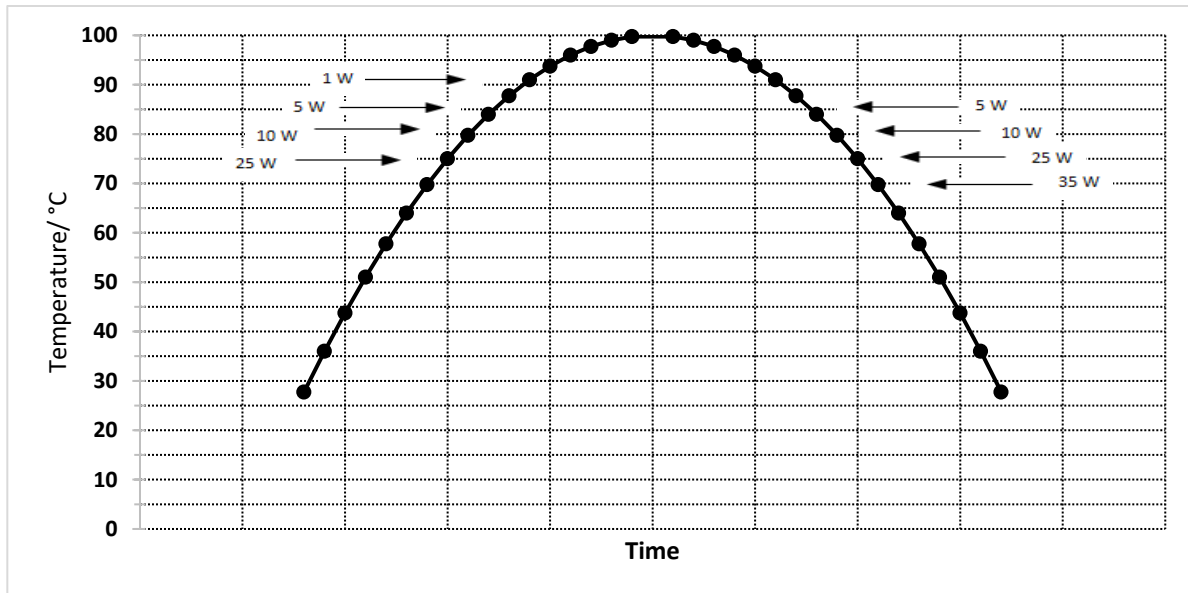

The modem has a built-in self protecting mechanism to prevent an RF power amplifier to overheat. The RF power amplifier temperature is measured and controlled regularly based on data from a temperature sensor on the printed circuit board. Because of the temperature is slowly changing phenomenon, the temperature is measured at the beginning of each transmission and every 10 s period thereafter.

LCD text	Condition	Remark
Temperature High RF output power reduced to x W	See table above.	

The temperature profiles below are taken from the heatsink, right below the RF-PA. Three different ambient temperatures were used, one in the room temperature without any forced air fluctuation whereas the other two cases were measured inside the Vötsch thermal chamber under the influence of a heating fan.

Three different duty cycle cases which are shown in the table below were measured with the following T_{on} and T_{off} times.

Duty Cycle/%	T_{on}/ms	T_{off}/ms
100	ON all time	-
75	850	280
50	850	850

It can be recognized decreasing or increasing temperature profiles in the first two figures, the locations where the decreasing occurs mean that the radio has decreased its RF output power for protecting the product from overheating. In the case of increasing temperature after decreasing period, means that the product has increased its RF output power inside the safety limits according to the tables above.

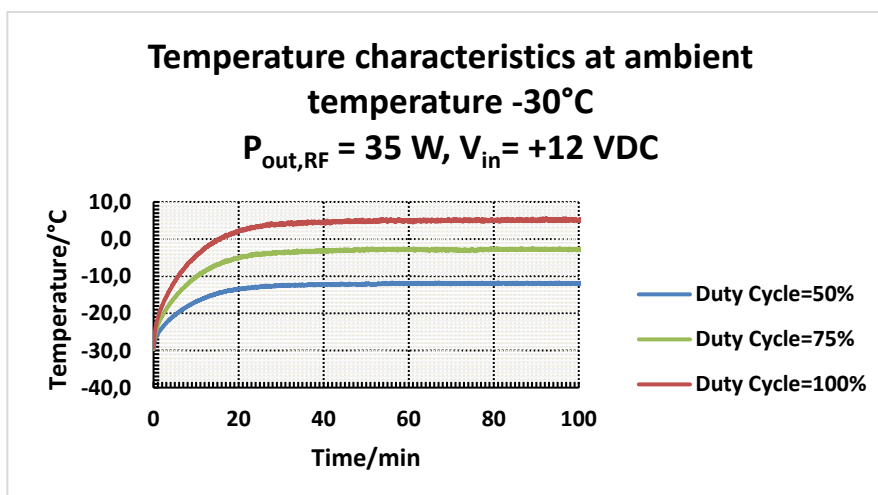
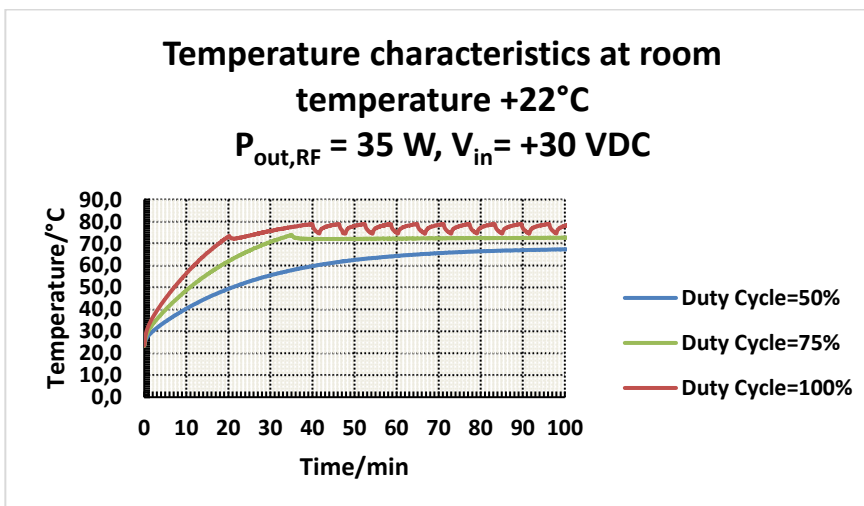
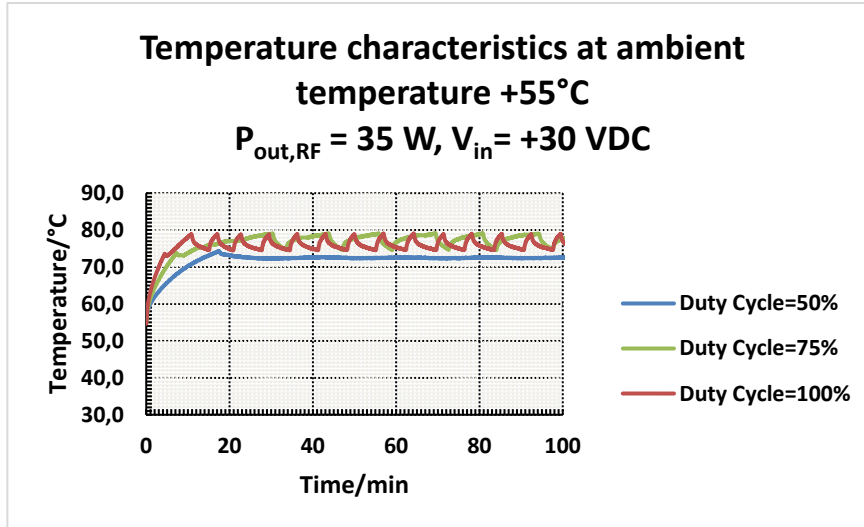

2.3 Input voltage

The modem is detecting and analysing the supply input voltage every 200 ms. If the voltage is deviating from the factory limit values, the modem will indicate it in LCD display with texts seen in the Table below.

LCD text	Condition	Remark
Voltage Critically Low Increase supply voltage above +9 V	Supply Input Voltage < +7.65 V	Transmission completely prevented.
Voltage Low Increase supply voltage above +9 V	Supply Input Voltage < +8.0 V	RF output power limited to +37 dBm (5 W)
Voltage High Reduce supply voltage below +30 V	Supply Input Voltage > +35.0 V	RF output power limited to +37 dBm (5 W)
Voltage Critically High Reduce supply voltage below +30 V	Supply Input Voltage > +36.3 V	Transmission completely prevented.

2.4 RF-PA voltage

The high power RF amplifier has an input voltage detecting and analysing ability. If the voltage is deviating from the factory limit values the modem will indicate it in an LCD display with texts seen in the Table below.

LCD text	Condition	Remark
PA Voltage Warning	Internal RF-PA voltage too low or high.	Output power is limited to +37 dBm (5 W). Restart the modem. Contact SATEL technical support if the malfunction still appears after 2-3 restarts
PA Voltage Critical	Internal RF-PA voltage critically low or high.	Transmission is completely terminated. Contact SATEL technical support.

3. LCD USER INTERFACE

3.1 LED-indicators

There are five (5) LED indicators on the front panel of the radio modem, and they give an indication of the status of the serial port and the radio interface:

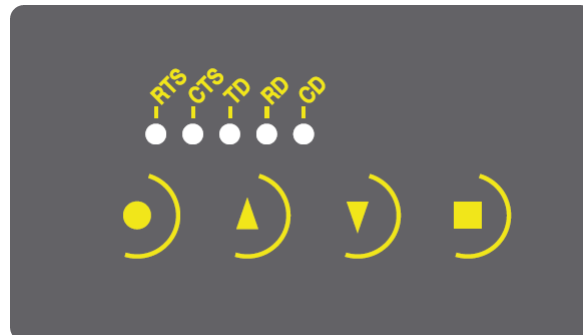

Description of the LED-indicators:

LED	Indication	OFF	Red	Orange	Green
RTS	RTS-line status	Inactive	Active		
CTS	CTS-line status	Inactive	Active		
TD	TD-line status	No data	Data		Test Tx active
RD	RD-line status	No data	Data		
CD	Radio status	No signal	Transmission	Noise	CD-line active

3.2 Display and push buttons

SATEL-EASy Pro+ includes a LCD (Liquid Crystal Display) with a backlight. In the *Data Transfer Mode* the display will show the operating settings of the radio modem, for example the radio field strength and the supply voltage. By using the push buttons and the display, it is possible to change most of the settings of the radio modem, without the need for an external terminal. The display backlight illuminates automatically as soon as a button is pressed.

When the SETUP-push button (■) is pressed, a settings menu is opened. It contains several sub-menus that can be selected in order to change the settings. You can always return to the previous higher level of the menu structure by pressing the CANCEL (or BACK) push button (●). Pressing the ▲ or ▼ button changes settings or moves in the menu. Selections are confirmed by pressing the SELECT or SET button. In case of numerical values the digit to be changed is selected by pressing the NEXT button (see following page).

The SATEL-EASy Pro+ includes following “LCD Mode” options:

- Normal (factory default)
 - Allows the user to read and change the parameters via push buttons and LCD display.
- Read-only
 - Allows the user to read the parameters from the display but modifying them is possible only via configuration software.
- SURV
 - Selectable parameters via LCD UI: channel, compatibility, Repeater -mode, FEC -mode. NOTE! Channel list forced ON. Channel list parameters must be configured properly. Asterisk (*) next to the power level means that the active power level is set to be lower than the current channel allows.
 - See chapter 10, “**Channel List**” for detailed information.
- SURV Read-only
 - Allows the user to read the SURV parameters from the display but modifying them is possible only via configuration software.
 - See chapter 10, “**Channel List**” for detailed information.

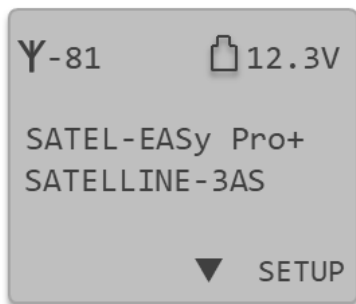

Normal/Read-only “LCD Mode”.

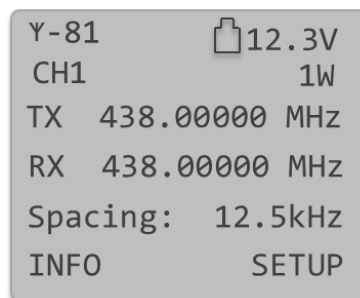

SURV/SURV Read-only “LCD Mode”.

The “LCD Mode” can be configured via SATEL NETCO DEVICE software tool or SL commands.

3.2.1 LCD menu navigation

Below is a figure for supported menu items and navigation in normal mode.

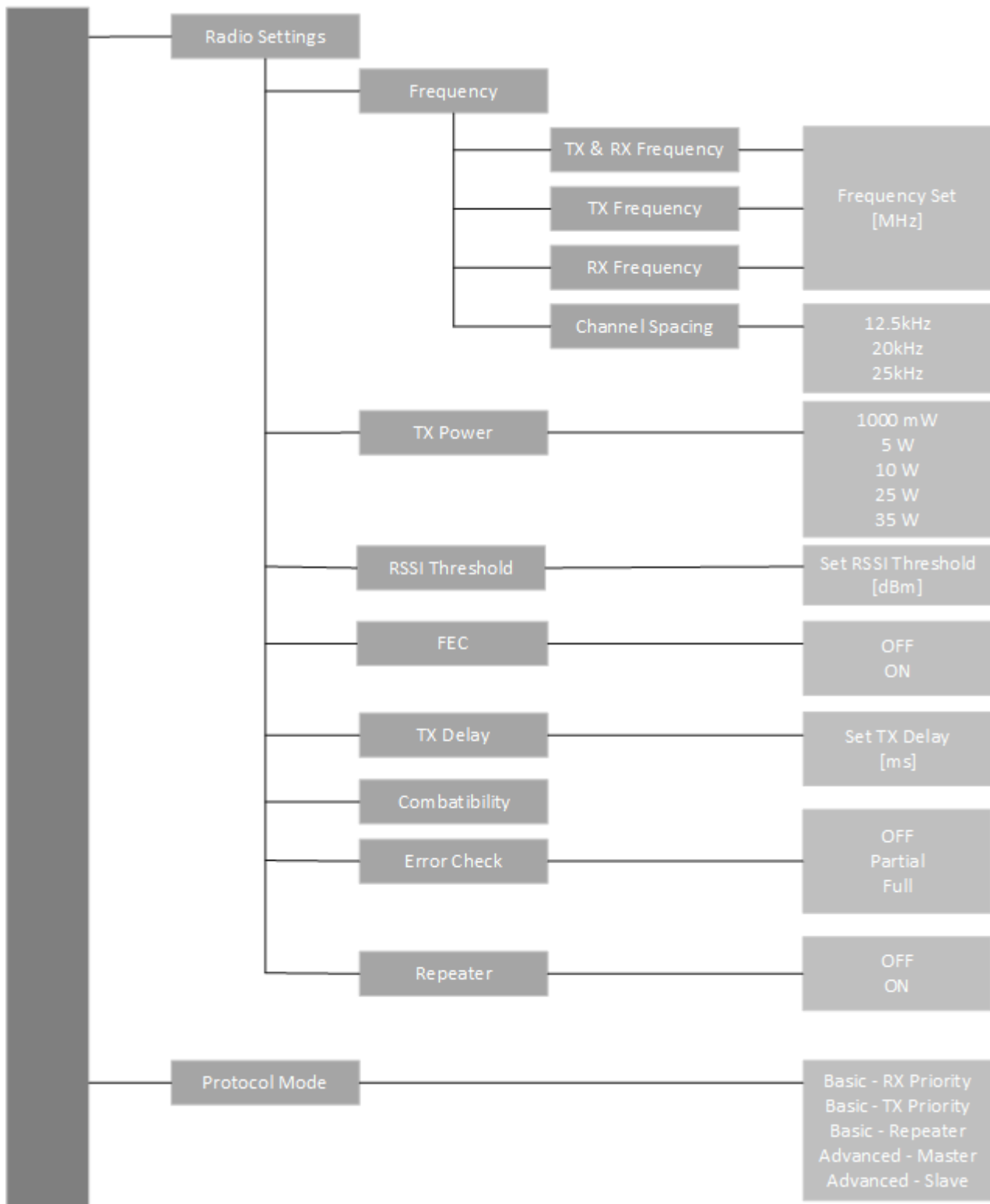

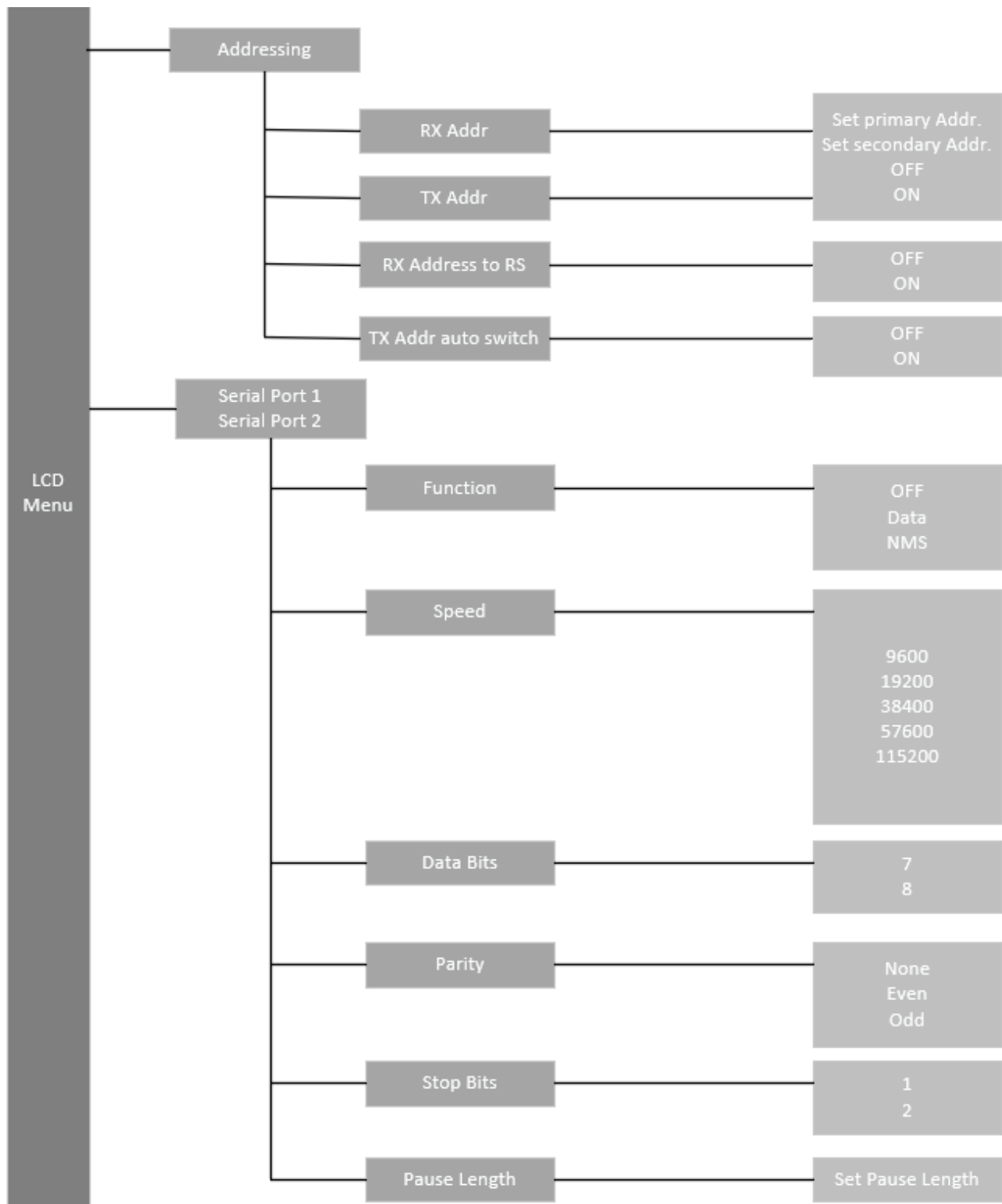

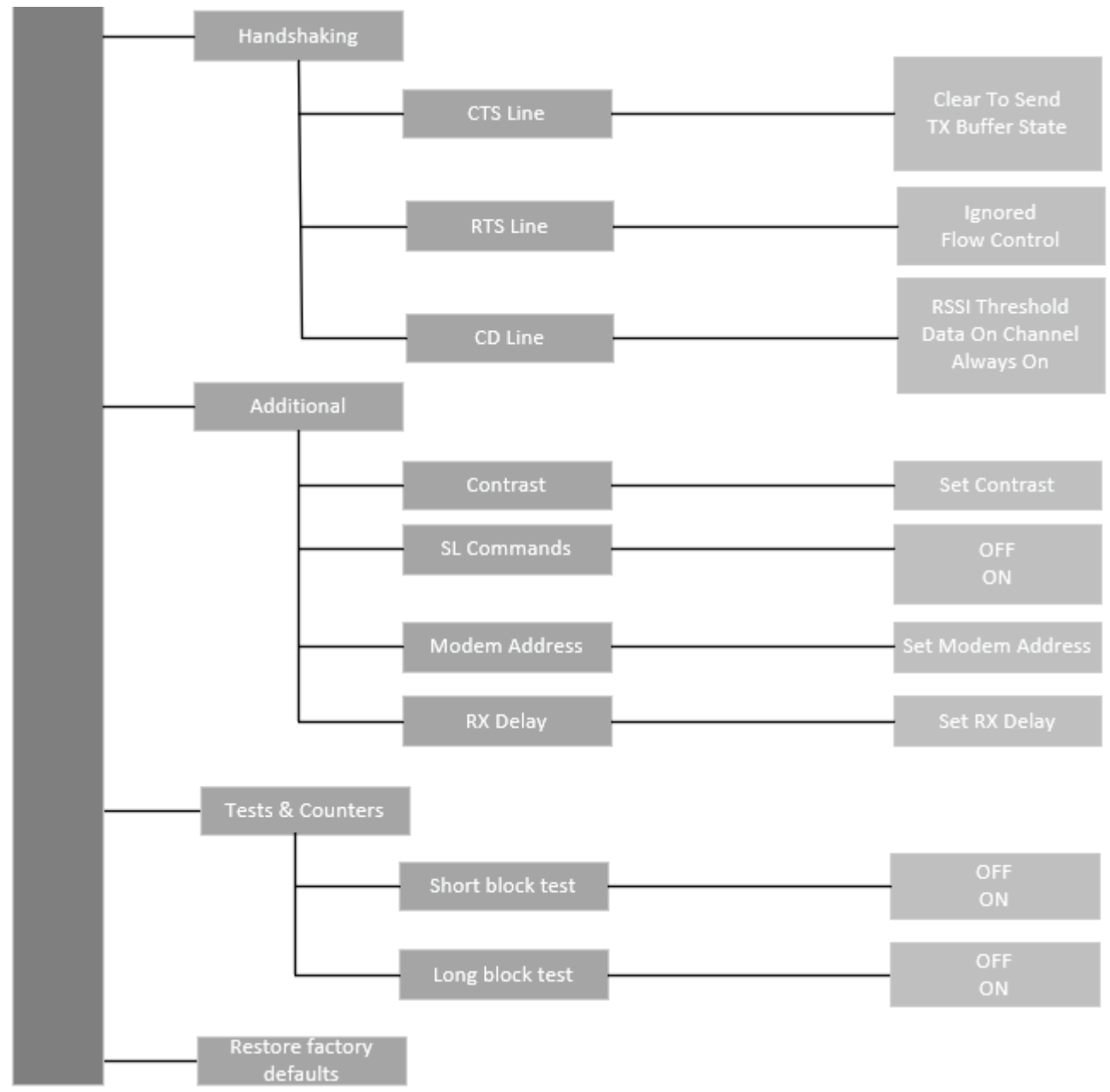

4. SERIAL DATA AND POWER INTERFACES

SATEL-EASy Pro+ radio modem has two variants: with one serial port or with two serial ports - *Port1* and *Port2*. With two serial port variant one of the ports is configured as the DATA port (by default *Port1*) that is connected to the user application. The other port is the NMS port (by default *Port2*) that is connected to the serial port of the PC running SATEL NETCO or SATEL NMS PC software.

The connectors are identical and the same cable can be used.

- HW variants:
 - 1 serial interface (a high standard waterproof ODU 8-pin)
 - Data port 1: RS232 (data/NMS)
 - 1 power interface (a high standard waterproof ODU 2-pin)

 - 2 serial interfaces (2 x high standard waterproof ODU 8-pin)
 - Data port 1: RS232 (data/NMS)
 - Data port 2: RS232/RS485/422, (data/NMS)
 - 1 power interface (a high standard waterproof ODU 2-pin)

NOTE!

When installing the cables of the serial interface, it is recommended that the operating voltage of all devices is powered OFF.

4.1 RS-232 interface

RS-232 standard defines the method of serial data transfer between a computer and its peripherals. The definition includes both the interface type and signal levels. Most computers and peripherals contain one or more RS-232 type serial ports. The RS-232 standard uses transmission lines, in which each single signal line level is referenced, to a common ground level. RS-232 has been designed to be use in serial transfer of data, in situations where the distance between communicating equipment is less than 15 m. The otherwise useful RS-232 standard is applied in a multitude of slightly differing ways, (e.g. different pin configurations) and for this reason different computers and peripherals are not necessarily directly compatible with each other.

4.2 RS-485 interface

RS-485 is an extension of the RS-422 standard and enables the connection of more than two devices on to the same bus. Communication is half-duplex so there is only one cable pair compared to two when using the RS-422. One cable pair carry both, transmitter and receiver signals, but not at the same time. The RS-485 standard defines the electrical characteristics of the connections to prevent possible data contention states as well as cable shorts etc. from harming the devices themselves. RS485 can be set on by altering the user settings.

4.3 RS-422 interface

RS-422 standard defines a serial data transfer method, which is similar to the RS-232 standard. In RS-422 however, the signal lines are differential transmission lines. Differential transmission line is formed by using two signal wires together which are in opposite polarity to each other. Because the state of the signal is defined by the mutual voltage difference (hence the name differential), any common mode disturbances induced into the lines will cancel out. Transmission distance can be considerably longer than when using RS-232 type of connection, and distances of 1 km are possible.

As an example, let's examine the TX-signal: TX-signal will be transmitted using two lines (A and B). A logic "1" corresponds to a situation where the voltage on line A is greater than the voltage on line B. Correspondingly a logic "0" corresponds to a situation, where the voltage on line A is smaller than the voltage on line B.

4.4 Port 1 wiring

Port 1 (8 pin ODU, GL1LAC-P08LFG0-0000)

- **DTE** is an abbreviation for **Data Terminal Equipment**
- **I/O** column below denotes the direction of the signal
- "IN" is from DTE to the radio modem, "OUT" is from the radio modem to DTE

PIN	NAME	I/O	LEVEL	EXPLANATION
1	RTS	IN	RS-232	Request To Send from DTE
2	CTS	OUT	RS-232	Clear To Send. This signal indicates that the radio modem's serial interface is ready to receive data from DTE.
3	GND	-	-	Signal ground
4	RD	OUT	RS-232	Receive Data to DTE from the radio modem
5	TD	IN	RS-232	Transmit Data from DTE to the radio modem
6	MODE (DATA/PROG)	IN	0-40V	Programming Mode Active <+1.5VDC or connected to ground Programming Mode Inactive >+3VDC or Not connected = Data Transfer Mode Note*
7	Not connected			
8	Not connected			

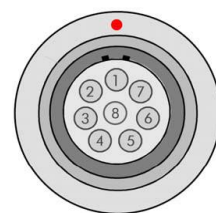

*) Programming Mode is for changing the settings of the radio modem. Normally the MODE line is NOT connected i.e. the radio modem is in Data Transfer Mode.

4.5 Port 2 wiring

Port 2 (8 pin ODU, GL1LAC-P08LFG0-0000)

- **DTE** is an abbreviation for **Data Terminal Equipment**
- **I/O** column below denotes the direction of the signal
- “IN” is from DTE to the radio modem, “OUT” is from the radio modem to DTE

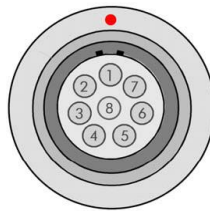

Pin	Pin name	RS-232		RS-422		RS-485	
		I/O	Signal	I/O	Signal	I/O	Signal
1	RTS	Input	RTS (IN)	Inverting input	TD- (IN)	No functionality	
2	CTS	Output	CTS (OUT)	Non-inverting output	RD+ (OUT)	Non-inverting input/output	D+ (IN/OUT)
3	GND						
4	RD	Output	RD (OUT)	Inverting output	RD- (OUT)	Inverting input/output	D- (IN/OUT)
5	TD	Input	TD (IN)	Non-inverting input	TD+ (IN)	No functionality	
6-8	Not connected						

4.6 Power connector

Power connector (2 pin ODU, G82B0C-P02LTS0-0000)

PIN	NAME	EXPLANATION
1	PWR (+)	Operation Voltage +9 ... +30 VDC
2	GND	Ground

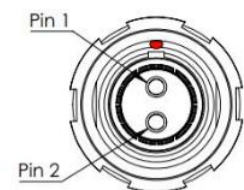

5. RF INTERFACE

SATEL-EASy Pro+ has a single TNC type RF-connector with impedance of 50 Ohm. When the modem is supplied, the frequency is set to “default channel”. The user can change the frequency afterwards according the amount seen on the specification section in this document. All local regulations set forth by the authorities must be taken into consideration.

The data speed of the radio interface is set to “default speed”. It can also be set afterwards. The data speed of the radio air interface depends on the modulation used irrespective of the data speed of the serial interface. If the data speeds of the radio air interface and the serial interface differ from each other, the radio modem will buffer the data in transfer temporarily, so no data loss will occur.

5.1 Transmitter

The output power of the transmitter is adjustable. The greatest allowable power depends on limits set by local authorities, which should not be exceeded under any circumstances. The output power of the transmitter should be set to the smallest possible level, which still ensures error free connections under variable conditions. Large output power levels using short connection distances can, in the worst case, cause disturbances to the overall operation of the system.

NOTE! Setting the radio data modem output power level to that which exceeds the regulations set forth by local authorities is strictly forbidden. The setting and/or using of non-approved power levels may lead to prosecution. SATEL and its distributors are not responsible for any illegal use of its radio equipment, and are not responsible in any way of any claims or penalties arising from the operation of its radio equipment in ways contradictory to local regulations and/or requirements and/or laws.

5.2 Receiver

The sensitivity of the receiver depends on the channel spacing of the radio modem (=data speed of the radio interface), used modulation and on the mode of the FEC (error correction) according to the table seen on the specification sheet.

The Signal Threshold Level setting of the receiver determines a level, above which the search for the actual data transfer signal is active. It is recommended that values given on the specification sheet are used. If the Signal Threshold Level setting is set too low (the CD-LED is ON constantly), it is possible that the receiver is trying to synchronise itself with noise, in which case, the actual data transmission might remain unnoticed. Alternatively, weak data transmissions will be rejected, even though they would be otherwise acceptable.

5.3 Encryption

The product encrypts the data that is transmitted on the air interface with the listed encryption techniques:

- AES128
- AES256 (DRM Feature)

Data security is often a concern when using radio communication. Bit encryption (CTR-mode) on the air-interface ensures privacy in the radio network. The principle of encryption in the radio path is to collect a certain amount of data to a shift register and manipulate it according to a certain rule. Every data packet is encrypted individually. Depending on the encryption type, the process of encryption adds 5-10ms delay in the data flow to each sent data packet (<5 characters in AES128 and <10 in AES256) and must be avoided in the cases where low latency is the most important requirement.

AES is open source software from public domain. Author: Brian Gladman (U.K). The CTR-mode is SATEL's in-house implementation.

Separate product models from the SATEL radio modem family supports the encryption for the RF interface. The models supporting this feature and encryption level can be viewed in SATEL WEB sites at www.satel.com/products/. The radio models that does not support the encryption feature are compatible with the radio models with the encryption when the feature is disabled. **It is not possible to update/change the models NOT supporting the encryption to support this feature in the field.** The factory default value for the encryption feature is OFF state. The setting state with the static, distributed encryption keys have to be set equally to the radios in the same radio network.

The encryption password key is generated by using Main and Aux –keys + in the beginning of the data packet transferred changing 32-bit string. It is mandatory to insert both information keys with the mentioned length keys.

Options for generating the encryption keys are:

- Manually via terminal connection:
 - o SL commands
- SATEL NETCO DEVICE
 - o <https://www.satel.com/products/software/>

It is recommended to set up a radio network with encryption enabled by using only one selected configuration way. The equivalency of the encryption keys between radio modems can be verified from the Key Hash –information field. Last 4 marks indicates the equivalency [0-9, A-F].

NOTE! The encryption is designed for SATELLINE-3AS, SATEL-8FSK-1, SATEL-8FSK-2, SATEL-16FSK-1 and SATELLINE 3AS NMS –radio compatibility modes.

5.4 Radio state

This setting allows users to disable/enable the transmitter. Unless overridden by the factory configuration, users can select state of the radio by using NETCO DEVICE:

- **Tx/Rx** both transmitter and receiver are enabled
- **Rx Only** transmitter disabled, receiver enabled

In case the factory configuration defines the modem as Rx-only device, the value can't be changed by the users.

NOTE: Rx Only device replies "0mW" to SL@P? (Get transmitter power) command.

5.5 Priority RX/TX

SATEL-EASy Pro+ offers a *Priority* setting, which selects the priority between reception and transmission. The setting can be changed with NETCO DEVICE, SL-commands or the LCD menu. By default, transmission has higher priority than reception i.e. the default value is Priority TX.

Priority TX means that a terminal device attached to a radio modem decides the timing of the transmission. The transmitter is immediately switched on when the terminal device starts to output data. Should reception be in progress, the radio modem will stop it and change to a transmit state. There is no need to use any handshaking for the control of timing.

Priority RX means that a radio modem tries to receive all data currently in the air. If a terminal outputs data to be transmitted (or an SL command) it will be buffered. The radio modem will wait until the reception has stopped before transmitting the buffered data. This will result in timing slacks to the system, but decreases the number of collisions on the air; this is particularly useful in systems based on multiple random accesses.

If the Repeater Function has been set on, priority setting is automatically switched to Priority RX mode.

5.6 Forward Error Correction

Forward Error Correction, **FEC**-function is switched ON (or OFF) by using SATEL SW tools, SL-commands or the LCD menu. When activated, the FEC-function will cause the SATEL-EASy Pro+ to automatically add additional error correction information, which increases the amount of transmitted data by 30 %. It is used by the receiving radio modem to correct erroneous bits - as long as the ratio of correct and erroneous bits is reasonable. FEC should be used on long distance links and/or if the radio channel is "noisy" in other words suffering from interfering signals.

Error correction improves the reliability of data transfer via the radio interface especially in unfavourable conditions. FEC-function should be used when link distances are long and/or if there are many disturbances in the radio channels used. The use of the FEC-function will, however decrease the data transfer throughput of data by about 30 %. The list of exact delays when using FEC-function, are introduced in appendix B.

NOTE!

All radio modems, which are to communicate with each other, must have the same setting for FEC (ON or OFF). If the transmitting radio modem and the receiving radio modem has different settings, data will not be received correctly.

5.7 Error checking

When the error checking is switched on, the radio modem will add a checksum to the transmitted data. When the data is received, the checksum is verified before data is forwarded to the serial port. Options for error checking can be accessed either via SL commands or SATEL SW tools (<https://www.satel.com/products/software/>). Setting must be set equally for all radio modems in the same network.

OFF (*default setting*). Received data is not verified at all. In practice, this is the fastest way to operate, because the data is given out from serial port immediately after it has been received. This is recommended method, if the application protocol already includes error checking functions.

Other modes differentiate according to active protocol as follows:

5.7.1 SATELLINE-3AS NMS -radio compatibility mode

Partial Error Check

This mode means that the radio modem checks the received data in small data blocks and sends the validated sub-messages to DTE. Once an error is detected, the rest of the message is ignored. That is, if an error takes place in the middle of a message, then the first part of the message is forwarded to the terminal device, but the data inside the erroneous sub-frame and the rest of the data will be ignored.

Full Error Check

In this mode the radio modem waits until the end of the reception and checks the whole received message before forwarding it to DTE. The additional time delay compared to No Error Check is roughly the time needed to transfer the user data message over the serial line.

5.7.2 SATELLINE-3AS mode

CRC8 Partial

Verifies the data in small blocks and they are delivered to DTE as sub messages after validating. Once an error is detected, the rest of the message is ignored. In practice, if the error appears in

the middle of the message, the first part is forwarded to DTE and the data in erroneous sub-message and after that will be lost.

CRC16 Full and CRC 8 Full check

Adds checksum characters accordingly at the end of the user data message. At the reception end the receiver receives first the whole package and if the checksum matches the data message is forwarded to the serial port.

! CRC-8 Partial and CRC-8 Full check activate an internal control on the radio link. These checksum types can't be viewed in the serial line data flow.

CRC-16 Full check adds the checksum to data. It is possible include the checksum into the received data in the serial line by setting the CRC16 Full check to OFF state at the receiving radio(s).

In typical use case, if checksum is preferred in the system, it is recommended to use the CRC-16 Full check -mode and set the parameter equally to the radios in the same radio network. Additional data transfer delay will be added approximately according to the data packet size to the total transfer delay.

CRC-16 Full and CRC-8 Full check features are designed for SATELLINE-3AS, SATEL-8FSK-1, SATEL-8FSK-2 and SATEL-16FSK-1 –radio compatibility modes.

5.8 Separate RX/TX-frequencies

The SATEL-EASy Pro+ can transmit (TX-frequency) and receive (RX-frequency) on separate frequencies. Separate frequencies can be set within the whole tuning range.

The frequencies can be set in the display menu or either via SL commands or SATEL NETCO DEVICE (<https://www.satel.com/products/software/>). When data flow on the TD line starts the frequency shifts from the receiving channel to the transmit channel. There is a delay caused by the frequency shift before the actual data transmission sequence starts, and the same time is needed for the return to the receive channel after transmission. The delay can be found on the specification page. The selected channel spacing, port settings etc. are equal to both frequencies.

5.9 Compatibility modes

5.9.1 Radio compatibility

SATEL provides several radio compatibility modes:

- for selecting the optimum radio solution that fits the application
- for enabling the interoperability between devices made by different manufacturers

SATEL-EASy Pro+ supports the original SATEL radio compatibility modes:

- SATELLINE-3AS (4FSK, FEC ON/OFF is selected by the separate FEC setting)
- SATEL-8FSK-1 (8FSK/FEC OFF)
- SATEL-8FSK-2 (8FSK/FEC ON)
- SATEL-16FSK-1 (16FSK/FEC ON)

Additional to the native SATEL radio compatibility modes, also the following radio compatibility modes are supported by the 403 - 473 MHz frequency band product variants.

- Pacific Crest compatible modes:
 - PacCrest-4FSK FEC ON/Scrambling ON
 - PacCrest-4FSK FEC OFF/Scrambling ON
 - PacCrest-4FSK FEC OFF/Scrambling OFF
 - PacCrest-4FSK FEC ON/Scrambling OFF
 - PacCrest-GMSK FEC ON/Scrambling ON
 - PacCrest-GMSK FEC OFF/Scrambling ON
 - PacCrest-GMSK FEC OFF/Scrambling OFF
 - PacCrest-GMSK FEC ON/Scrambling OFF
 - PacCrest-FST 4FSK/FEC ON
 - PacCrest-FST 4FSK/FEC OFF
 - PacCrest-GMSK FEC ON, Scrambling ON, 4800 bps, 25 kHz
 - PacCrest-GMSK FEC OFF, Scrambling ON, 4800 bps, 25 kHz
 - PacCrest-GMSK FEC OFF, Scrambler OFF, 4800 bps, 25 kHz
 - PacCrest-GMSK FEC ON, Scrambler OFF, 4800 bps, 25 kHz

- Trimble compatible modes:
 - TrimTalk450s(P) GMSK, Rx fitted to PacCrest transmitters
 - TrimTalk450s(T) GMSK, Rx fitted to Trimble transmitters
 - TrimTalk v1, GMSK, 8/16 kbps
 - TrimTalk 4800 bps, 25 kHz

- RTCM SC135 modes – these are based on RTCM (Radio Technical Commission for Maritime Services) standard 13500.1 on Radio Layer for Real-Time DGNS Applications.
 - RTCM SC135 1 (25 kHz, FEC ON)
 - RTCM SC135 2 (12.5 kHz, FEC ON)
 - RTCM SC135 3 (25 kHz, FEC OFF)
 - RTCM SC135 4 (12.5 kHz FEC OFF)

Notes:

- Supported compatibility options may vary depending on the model and factory configuration.
- All radio modems of a system must have identical FEC (ON or OFF) and Scrambling (ON or OFF) settings.
- The implementation of the non-native radio compatibility options is based on the reference measurements and the available public data of the following radio modems manufactured by Pacific Crest Corporation: ADL, RFM96W, PDL HPB, PDL LPB.
- TRIMTALK is a trademark of Trimble Navigation Ltd.

SATEL-EASy Pro+ radio modem provides the following radio compatibility settings with the data rates seen below:

Channel Bandwidth → Air Interface Speed/bps Compatibility Mode	12.5 kHz					25 kHz					
	4800	7200	8000	9600	14400	4800	9600	14400	16000	19200	28800
SATELLINE-3AS FEC OFF				X						X	
SATELLINE-3AS FEC ON		X						X			
SATEL-8FSK-1 (FEC OFF)					X						X
SATEL-8FSK-2 (FEC ON)				X						X	
SATEL-16FSK-1 (FEC ON)					X						X
TrimTalk450s	X		X			X	X		X		
PacCrest-GMSK	X					X	X				
PacCrest-FST (4FSK)				X						X	
PacCrest-4FSK				X						X	

The implementation of Options 1, 2, 3 is based on the reference measurements and the available public data of the following radio modems manufactured by Pacific Crest Corporation: RFM96W, PDL HPB, PDL LPB. TRIMTALK is a trademark of Trimble Navigation Ltd.

5.9.2 Configuration by using SL commands

“SL@S=” command selects the compatibility mode:

- 0 = SATELLINE-3AS
- 1 = PacCrest-4FSK (FEC ON, Scrambler ON)
- 2 = PacCrest-GMSK (FEC ON, Scrambler ON)
- 3 = TrimTalk450s(P) (Rx fits PacCrest modems)
- 4 = Trimtalk450s(T) (Rx fits Trimble modems)
- 5 = PacCrest-FST (FEC ON)
- 20 = SATEL-8FSK-1 (FEC OFF)
- 21 = SATEL-8FSK-2 (FEC ON)
- 22 = SATEL-16FSK-1 (FEC ON)
- 23 = PacCrest-4FSK (FEC OFF / Scrambler ON)
- 24 = PacCrest-GMSK (FEC OFF / Scrambler ON)
- 25 = PacCrest-FST (FEC OFF)
- 26 = PacCrest-4FSK (FEC OFF / Scrambler OFF)
- 27 = PacCrest-GMSK (FEC OFF / Scrambler OFF)
- 28 = PacCrest-4FSK (FEC ON / Scrambler OFF)
- 29 = PacCrest-GMSK (FEC ON / Scrambler OFF)
- 34 = RTCM SC135 1 25 kHz FEC ON
- 35 = RTCM SC135 2 12.5 kHz FEC ON
- 36 = RTCM SC135 3 25 kHz FEC OFF
- 37 = RTCM SC135 4 12.5 kHz FEC OFF

Example; "SL@S=0". The modem responds with "OK" message if the requested mode is supported or "ERROR" if the mode is not allowed.

"SL@S?" enquires the active mode. The modem responds with a number:

- "0" if the mode is SATELLINE-3AS
- "1" if the mode is PacCrest-4FSK
- "2" if the mode is PacCrest-GMSK
- "3" if the mode is TrimTalk450s(P) (Rx fits PacCrest modems)
- "4" if the mode is Trimtalk450s(T) (Rx fits Trimble modems)
- "5" if the mode is PacCrest-FST
- etc.

5.9.3 **Settings**

In order to use the Pacific Crest/TRIMTALK modes implemented in SATEL modems:

PACIFIC CREST modems must have:

- Protocol Mode
- Transparent w/EOT Timeout (when using Pacific Crest modulations)
- TrimTalk 450s (when using TRIMTALK GMSK modulation)
- Transparent FST
- Modulation Type depends on the system
- GMSK (default, always selected when using TRIMTALK 450s mode)
- 4-Level-FSK
- FEC = ON/OFF
- Scrambling = ON/OFF
- Data Security Code set to = 0 (=not used)
- Local Address= 0...254 (0 by default)
Pacific Crest modem receives messages from SATEL modems that have their TX1 address matching the Local Address.

Remote address=0...255 (255 by default, that is the broadcast address to be received by all). SATEL modems receive the message from a Pacific Crest modem, provided their RX1 address matches the Remote Address of a Pacific Crest transmitter (or if the message has the broadcast address 255).

SATEL modems must have the following key settings:

- FEC OFF (because the FEC here means SATEL 3AS FEC, not Pacific Crest/TRIMTALK FEC)
- Error check OFF
- Radio Compatibility (according to selected Pacific Crest protocol mode setting)

When TX address is selected ON, then TX1 address is used like PDL Remote address that is the destination address for the transmitted messages. Default value is 0x00FF (=255) (note the hexadecimal format of the setting).

When RX Address is selected ON, then RX1 address is used like PDL Local address. Default value is 0x0000 (=0) (note the hexadecimal format of the setting).

Addresses are NOT applicable in TRIMTALK 450s mode so SATEL modems must have their RX/TX addresses OFF with Option3.

The configuration tools and settings are different between SATEL and Pacific Crest modems:

- Pacific Crest modems are configured via the serial port using PDLCONF Windows™ program that sends binary control messages to the serial port of the modem.
- SATEL-EASy Pro+ radio modems are configured via the serial port using NETCO DEVICE or terminal program and SL commands.

The table below shows the analogy of settings between Pacific Crest and SATEL radio modems.

Pacific Crest setting	Corresponding SATEL-EASy Pro+ setting
Identification: Owner	(not implemented)
Identification: Channel Bandwidth	Channel spacing
Identification: RF Power	TX power
Radio Link: Channel Selection Type (Manual)	Radio frequency
Radio Link: Current Channel	Radio frequency
Radio Link: Link Rate	The fixed link rates are: Option 2 & 3: 9600 bps @ 25 kHz / 4800 bps @ 12.5kHz Option 1: 19200 bps @ 12.5 kHz / 9600bps @ 12.5 kHz
Radio Link:Modulation Mode	Compatibility->PCC-4FSK Compatibility->PCC-GMSK Compatibility->TRIMTALK GMSK
Radio Link:Scrambling	ON by default
Radio Link:Transmit Retries	(not implemented)
Radio Link:TX ACK Timeout	(not implemented)
Radio Link:Cdma Monitoring	Priority (RX=ON, TX=OFF) Default: RX
Radio Link: AutoBase/AutoRover	(not implemented)
Radio Link:Digisquelch	Signal threshold
Radio Link:Forward Error Correction	ON by default using Option 1, 2, 3 (Note: SATEL-EASy Pro+ FEC must be OFF!)
Radio Link:Local Address (0 by default)	Primary RX address (RX1) (OFF by default)
Radio Link:Remote Address (255 by default)	Primary TX address (TX1) (OFF by default)
Serial Interface:Protocol Mode	Radio compatibility: Options 1 and 2 = Transparent w/EOT Timeout Option 3 = TRIMTALK 450s, RX fitted to PCC Option 4 = TRIMTALK 450s, RX fitted to Trimble Option 5 = PCC Transparent FST
Serial Interface:BREAK to Command	(not implemented)
Serial Interface:Modem Enable: Yes	(not applicable)

Serial Interface:Soft Break Enable	(not implemented)
Serial Interface:EOT value (in 0.01s units)	Pause length (in serial port byte intervals)
Serial Interface:Digipeater Delay (in 0.01s units)	(not implemented)
Serial Interface:Local Node Repeater	(not implemented)
Frequency Table	Radio frequency
Data Security Code (must be 0=not used)	(not implemented)
<p>Potential conflicts: FEC setting applies only to the SATELLINE-3AS mode, the other radio compatibility modes have their own FEC bindings (although some previous or special firmware versions differ in the way FEC setting is handled - in case of doubt please contact technical support) Error check and Full CRC16 check must be OFF in SATEL modem SATELLINE RX/TX addressing does not use ARQ scheme like Pacific Crest radios</p>	

5.9.4 Repeater function

The implemented Pacific Crest/TRIMTALK modes support also the repeater function. The repeater function is configured either by using the SL commands:

- "SL@M=R" (Repeater ON)
- "SL@M=O" (Repeater OFF)

or by selecting Repeater OFF/ON in the Radio Settings -> Repeater LCD menu.

Note 1. The repeater modem passes TRIMTALK messages also to its serial port unlike for example Pacific Crest PDL modems.

Note 2. If error correction is ON (FEC ON) and TRIMTALK mode is activated by using "SL@S=3" command, the firmware automatically switches SATEL FEC OFF temporarily, and turns it back at the mode return.

Note 3. Unlike SATELLINE-3AS and Pacific Crest -compatibility modes, TRIMTALK -compatibility mode doesn't support acting as a remote station when configured as Repeater (incoming data from radio interface not forwarded to serial port).

5.9.5 Support for Local / Remote addresses

If the modem has TX address ON then primary TX address is handled in the same way as Remote address in Pacific Crest PDL modems. The default value is 0x00FF (255 in decimal format) i.e. the broadcast address.

If the modem has RX address ON then primary RX address is handled in the same way as PDL Local address in Pacific Crest PDL modems. The default value is 0x0000 (0 in decimal format). SATELLINE modem needs to have TX Delay 50 ms or more in order to avoid messages from colliding in case it is to be placed in a Pacific Crest system that uses addressing and acknowledging scheme.

In case only broadcast messages are used (like in RTK applications) there is usually no need for TX Delay, except if the transfer delays identical to Pacific Crest modems are preferred – in such cases an appropriate value of TX Delay is 34 ms.

Note 1. SATELLINE-modems do not support Pacific Crest retransmit/acknowledge scheme. However, that has no effect in RTK applications because they utilize only broadcast messages.

6. TRANSPARENT DATA TRANSMISSION

6.1 Serial interface, data format

The SATEL-EASy Pro+ serial interface uses an asynchronous data format. No external synchronising signal is needed, since necessary timing information is acquired from the start and stop bits transmitted before and after each data field bits (byte).

The data transfer speed of the serial interfaces can be set to 9600, 19200, 38400, 57600 or 115200 bps (**b**its **p**er **s**econd). The length of the data field must be 8N1, 8N2, 8E1, 8E2, 8O1, 8O2, 7E1, 7E2, 7O1, 7O2

If the settings of data speed, character length, parity or the number of stop bits differ between the radio modem and the terminal, errors will be introduced into the transferred data. The serial port settings of each individual radio modem in a system can all be different apart from the data length setting (7 or 8), which must always be the same in each individual radio data modem. In other words, the serial port used, the data transfer speed, parity and number of stop bits; can be different in different parts of a same system. This is especially useful where one part of the system uses an RS-485 serial port and another part uses the RS-232 serial port. In other words, radio modems may also be utilised as serial port converters in addition to the more common role of wireless data transfer.

Serial interface settings of the modem and terminal device connected to it must match.

6.2 Handshake lines

When using the RS-232 serial interface, handshake signals can be used to control data transfer. Handshake signals are used, for example, by the radio modem to inform the terminal that the radio channel is busy, and that it cannot initiate transmission. The terminal can also control the radio modem via RTS-line.

Line	Direction
CTS	To terminal
RTS	To modem

A common way of using handshaking signals is to monitor the CTS-line and ignore the others. Usually the terminal is fast enough to handle the data received by the radio modem, so the use of RTS-line is not necessary.

Handshaking is not needed if the system protocol is designed to prevent collisions (data contention) by the use of polling, or if there is little traffic and also if there is no harm from occasional data contention situations (several radio modems try to transmit at the same time).

6.2.1 **CTS-line**

The options for CTS-line are:

1) Clear To Send

CTS is active when the radio modem is ready to accept data for new transmission. CTS will shift into inactive state during data reception and transmission.

2) TX buffer state

CTS will shift into inactive state only if the radio modem's TX buffer is in danger of overflowing. This typically happens when the serial interface data transfer speed is greater than the radio interface transfer speed and the size of transmitted messages is large.

6.2.2 **CD-line**

The CD handshaking options are not supported by SATEL-EASy Pro+ modems, the status of the CD-line can only be seen in the CD LED. The options for CD-line are:

1) RSSI-threshold

CD is active whenever a signal with a level exceeding the level required for reception exists on the radio channel. It doesn't make any difference if the signal is an actual data transmission, a signal of a radio transmitter not belonging to the system, or even an interference signal caused for example, by a computer or a peripheral device. CD is also active when the radio modem in question is transmitting.

2) Data on channel

CD will switch to active state only after recognition of a valid data transmission. CD will not react to interference signals.

3) Always ON

CD is always in the active state. This option can be used with terminal equipment, which use the CD-line as an indicator of an active connection (the radio modem can transmit and receive at any time).

6.2.3 **RTS-line**

The options for RTS-line are:

1) Ignored

RTS-line status is ignored.

2) Flow control

The radio modem transmits data to the terminal device only when the RTS-line is active. Non-active state of the RTS-line will force the radio modem to buffer the received data. This option is used if the terminal device is too slow to handle data received from the radio modem.

3) Reception control

RTS-line controls the reception process of the radio modem. An active RTS-line enables reception (as normal). Non-active RTS-line will interrupt reception process immediately, even if the radio modem is receiving a data packet. This option is used to force the radio modem into WAIT State for an immediate channel change.

6.3 Timing and delays during data transmission

When using a radio modem for data transmission, certain delays will be formed through the use of a radio interface and from the radio modem circuitry itself. These delays exist when the radio modem switches from *Standby Mode* to *Data Transfer Mode* and during reception and transmission of data. For detailed delay values in each case see Appendix B.

6.3.1 Data buffering in the radio data modem

Whenever the radio modem is in *Data Transfer Mode* it monitors both the radio channel and the serial interface. When the terminal device starts data transmission the radio modem switches to transmission mode. At the beginning of each transmission a synchronisation signal is transmitted and this signal is detected by another radio modem, which then switches into receive mode. During the transmission of the synchronisation signal the radio modem buffers data into its memory. Transmission ends when a pause is detected in the data sent by the terminal device, and after all buffered data has been transmitted. When the serial interface speed is the same or slower than the speed of the radio interface, the internal transmit buffer memory cannot overflow. However, when the serial interface speed exceeds the speed of the radio interface, data will eventually fill transmit buffer memory. In this instance, it will take a moment after the terminal device has stopped transmission of data for the radio modem to empty the buffer and before the transmitter switches off. The maximum size of transmit buffer memory is one kilobyte (1 kB). If the terminal device does not follow the status of the CTS-line and transmits too much data to the radio modem, the buffer will be emptied and the transmission is restarted.

In the receive mode, the buffer works principally in the above described way thus evening out differences in data transfer speeds. If the terminal device transmits data to a radio modem in receive mode, the data will go into transmit buffer memory. Transmission will start immediately when the radio channel is available.

6.3.2 Pause length

The modem recognises a pause on the serial line (a pause is defined as a time with no status changes on the RS-232 interface TD-line). The pause detection is used as criteria for:

- **End of radio transmission** - When the transmit buffer is empty and a pause is detected, the modem stops the transmission and will then change the radio to the receive mode.
- **SL-command recognition** - For a SL-command to be valid, a pause must be detected before the actual "SL..." character string.

- **User address recognition** - In order for the start character to be detected, a pause must precede it in transmission.

Traditionally, in asynchronous data communication, pauses have been used to separate serial messages from each other. However, the use of non-real-time operating systems (frequently used on PC-type hardware) often adds random pauses, which may result in the user data splitting into two or more separate RF transmissions. This may cause problems especially in the systems including repeater stations.

In order to match the operation of the radio modem to the user data, the Pause length parameter can be adjusted either by using SL command or SATEL NETCO DEVICE SW program. It may have any value between 3 and 255 characters. The default value is 3 characters.

Notes:

- The absolute time of Pause length is depending on the serial port settings. For example, 1 character is ~1.04 ms at 9600 bps / 8N1 (10 bits).
- An increase in the Pause length increases the round trip delay of the radio link correspondingly; this is due to the fact that the radio channel is occupied for the time of the Pause length after each transmission (the time it takes to detect a pause). If this is not acceptable, the TX delay setting may also be useful in special cases.

6.3.3 **TX delay**

The radio modem can be configured to delay the beginning of a radio transmission by 1...65000ms. This function can be used to prevent packet contention in a system, where all substations would otherwise answer a poll of a base-station simultaneously. During this delay data sent to the radio modem is buffered. Although the priority setting is "RX", radio modem is prevented to change over to receiving mode during the period of the TX delay. If this function is not needed, the delay time should be set to 0 ms.

6.3.4 **RX delay**

Functions like TX delay, but applies to received data. Valid values are 0...255 ms, the radio modem waits before starting to forward data to RD line. Data is buffered during the delay. 0 ms means no delay.

7. TEST MODES

The radio modem can be switched to a Test Mode in which it will send test messages to the radio channel. Test messages can be utilized for example when directing antennas during system installation. The transmitting radio modem needs only a power supply and an antenna in the test mode but no external terminal device.

If the test mode has been set ON, the radio modem starts to transmit test messages immediately after a reset or a power-up. Test messages are treated as normal data at the receiver side. The recommended data speed at the serial port of the receiving radio modem is 38400 bps @ 25 kHz radio channel or 19200 bps @ 12.5 kHz.

The test modes are designed for SATELLINE-3AS, SATEL-8FSK-1, SATEL-8FSK-2, and SATEL-16FSK-1 radio compatibility modes.

7.1 Short block test

In this test mode the radio modem sends a short test message that is preceded by a consecutive number and terminated by the Carriage Return and Line Feed characters. The test messages are repeated continuously at 1 second intervals. The short block test is suitable for running radio link tests. Reception of data can be monitored using a suitable terminal program.

Example of short data blocks:

```
00 This is a test line of SATELLINE-3AS radio modem
01 This is a test line of SATELLINE-3AS radio modem
```

7.2 Long block test

In this test mode the radio modem transmits a test message continuously for 50 s. After 10 s break the test transmission is started again. The transmission sequence is repeated continuously. The long block test can be used in order to measure the transmitter output power or RSSI (Received Signal Strength Indicator) level at the receiver stations. RSSI can be monitored easily on the LCD display of the receiving modem or by using SL command "SL@R?".

Example of a long data blocks:

```
99 This is a long test line of SATELLINE-3AS radio modem
00 This is a long test line of SATELLINE-3AS radio modem
```

The strength of the received signal can be monitored using the LCD-display of the receiving radio modem.

NOTE 1! Green TD led indicates active test mode.

NOTE 2! Normal data transfer is not available while the Test mode is active. Remember to switch it OFF before starting the normal data transfer.

8. SETTINGS

The configuration of settings can be changed in several ways. User can choose several methods such as:

LCD menu & Push buttons (the models equipped with a display)

The basic settings are accessible from LCD and push buttons. Some of the functions, for example the Channel list editing or configuration of Message routing is to be performed using PC software.

SL commands

A terminal device can command or configure the radio modem by using special commands. SL commands are applied especially in cases where radio modems are to be integrated seamlessly inside a system behind the integrator's own user interface.

SATEL NETCO DEVICE

SATEL NETCO DEVICE is a software for configuring and reprogramming a SATEL device. The configuration parameters can be read and written from/to the locally connected, powered device. The device configuration can be also created/saved/explored from/to a file without device connection.

List of settings	
Setting	Description and value range
TX frequency	The radio frequency of the transmitter The value must be: <ul style="list-style-type: none"> • 403...473 MHz • less than frequency band upper limits • more than frequency band lower limits • divisible by 6.250 kHz (if Channel spacing is 12.5 or 25 kHz) • divisible by 10 kHz (if Channel spacing is 20 kHz) Default value: 438.000 MHz
RX frequency	The radio frequency of the receiver The value must be: <ul style="list-style-type: none"> • 403...473 MHz • less than frequency band upper limits • more than frequency band lower limits • divisible by 6.250 kHz (if Channel spacing is 12.5 or 25 kHz) • divisible by 10 kHz (if Channel spacing is 20 kHz) Default value: 438.000 MHz
Reference Frequency	Nominal frequency to which RX or TX frequencies are referenced to when using SL commands "SL&+=" and "SL&-=". In most cases the setting can be ignored. The value must be in range of 403...473 MHz.

	Default value: 438.000 MHz
Channel Spacing (Width)	12.5, 20 or 25 kHz Channel spacing defines the frequency difference between adjacent radio channels. In the context of SATEL-EASy Pro+ modems it also defines the width of the radio channel. Default value: 12.5 kHz
Tx Power	EASy Pro+ supports transmitter output power levels: 1W, 5W, 10W, 25W and 35W. Default value: depending on regional code 25W or 35W
Signal threshold	RSSI Signal threshold defines the minimum power level (dBm) of the radio signal to be received. Any transmissions below the threshold level are ignored. Note that the greater the absolute value is the weaker is the signal threshold level (-110 dBm is weaker than -90 dBm). Value range is -80 ... -118 dBm. Default value: -115 dBm
Channel list	Selects whether the list of predefined radio channels is used for the configuration of radio parameters. Default value: Channel list OFF
TX Start Delay	Defines the extra time (0...65000 ms) the radio modem waits before starting to transmit. Data is buffered during the delay. Default value: 0 ms (=no delay)
RX Delay	Defines the extra time (0...255 ms) the radio modem waits before starting to forward data to RD line. Data is buffered during the delay. Default value: 0 ms (=no delay)
Radio Compatibility	Defines the radio protocol. Options are SATELLINE-3AS, SATELLINE-3AS NMS, SATEL-8FSK-1, SATEL-8FSK-2, SATEL-16FSK-1, PacCrest-4FSK, PacCrest-GMSK TrimTalk450s (P), TrimTalk450s (T), PacCrest-FST, RTCM SC135 1 25kHz FEC On, RTCM SC135 2 12.5kHz FEC On, RTCM SC135 3 25kHz FEC Off, RTCM SC135 4 12.5kHz FEC Off. Default value: SATELLINE-3AS
Call Sign	Call sign means that the modem transmits its Call sign ID periodically using Morse keying. Call sign is configured using three settings: a) Call sign mode sets Call sign operation ON/OFF. b) Call sign ID defines Morse code to be transmitted, max. sixteen characters, capital letters and numbers are allowed (lower case letters are converted automatically to uppercase letters). If Call sign mode is not used (OFF) you can enter e.g. "CALLSIGN" for the Call sign ID. c) Call sign timer is the interval (1...30 min) between Call sign transmissions.

	One Call sign transmission may take several seconds to transmit, depending on the Call sign ID. Default value: Call sign mode OFF
RX Address	See the chapter REPEATER MODE AND ADDRESSING Default value: OFF (Rx Address Disabled)
TX Address	See the chapter REPEATER MODE AND ADDRESSING Default value: OFF (Tx Address Disabled)
RX addressing to RS port	See the chapter REPEATER MODE AND ADDRESSING Default value: OFF
TX address auto switch	See the chapter REPEATER MODE AND ADDRESSING
Serial port 1 Status	Defines Port 1 status Options are: OFF/Diagnostics (NMS)/Data Default value: Data
Serial port 1 Interface	RS-232 (fixed)
Serial port 1 Data speed	9600, 19200, 38400, 57600, 115200 bps Default value: 115200 bps
Serial port 1 Data bits	7 <i>Note**</i>), 8 bits Default value: 8 bits
Serial port 1 Parity bit	None, Even, Odd Default value: None
Serial port 1 Stop bits	1 or 2 Default value: 1
Serial port 2 Interface)	Available selection: RS-232/422/485 Default value: RS-232
Serial port 2 Data speed)	9600, 19200, 38400, 57600, 115200 bps Default value: 115200 bps
Serial port 2 Data bits)	Fixed to be 8 bits
Serial port 2 Parity bit)	None, Even, Odd Default value: None
Serial port 2 Stop bit)	1 or 2 Default value: 1
CTS handshaking	Defines how CTS line acts, the choices are: Clear to send, TX buffer state, Duty Cycle Default value: Clear to send
CD handshaking	Defines how CD line acts, the choices are: RSSI-threshold, Data on channel, Always ON. Default value: RSSI- threshold
RTS handshaking	Defines how RTS line acts, the choices are: Ignored, Flow Control. Default value: Ignored

*) Separate models available with Port 2 option.

Pause length	<p>The radio modem recognizes pauses on the serial line and uses them as criteria for ending the transmission and finding SL commands. The value range is 3....255 bytes.</p> <p>In case the serial port data to be transmitted includes pauses between the characters inside messages, increasing Pause length will help in keeping the message in one part over the radio. In general, the value should be kept as small as possible in order to maximize the performance of the radio system.</p> <p>Default value: 3 (Port1) Default value: 5 (Port2)</p>
Error correction (FEC)	<p>ON/OFF</p> <p>FEC (Forward Error Correction) improves the reliability of data transfer over a noisy radio channel. FEC is recommended in case the link distances are long or if the radio channel is not clean. However, FEC ON decreases the data transfer speed by about 30 % (depending on used modulation level).</p> <p>All radio modems, that are to communicate with each other, must have the same setting for FEC (ON or OFF).</p> <p>Note that FEC setting applies only to the SATELLINE-3AS radio protocol, the other radio compatibility modes have their own FEC bindings (although some previous or special firmware versions differ in the way FEC setting is handled - in case of doubt please contact technical support)</p> <p>Default value: OFF</p>
Error check	<p>ON/OFF</p> <p>Default value: OFF</p> <p>0 = Error check off 1 = CRC8 Partial 2 = CRC8 Full 3 = CRC16 Full</p>
Repeater	<p>Repeater Mode selects whether the radio modem forwards the received messages over the radio or not.</p> <p>Addressing must be also used in the systems that include more than one repeater, in order to prevent the messages bouncing between the repeater stations.</p> <p>Default value: OFF</p>
SL commands	<p>SL command mode ON/OFF</p> <p>When enabled, the modem can be configured/controlled by using the SL commands.</p> <p>Default value: ON</p>
Priority	<p>TX or RX</p> <p>Default value: TX</p>

LCD Mode	<p>Normal (factory default)</p> <ul style="list-style-type: none"> - Allows the user to read and change the parameters via push buttons and LCD display <p>Read-only</p> <ul style="list-style-type: none"> - Allows the user to read the parameters from the display but modifying them is not possible via LCD UI. <p>SURV</p> <ul style="list-style-type: none"> - Selectable parameters via LCD UI: channel, compatibility, Repeater -mode, FEC -mode. NOTE! Channel list forced ON. Channel list parameters must be configured properly. <p>SURV Read-only</p> <ul style="list-style-type: none"> - Allows the user to read the SURV parameters from the display but modifying them is not possible via LCD UI.
Add RSSI to data	<p>If the function is ON, RSSI information is appended to the received data. RSSI info "\02RSSI:-nnn dBm\03\0D\0A" in the end of serial port messages, nnn is three digit decimal number. Default value: OFF</p>
Region Code	<p>Region code defines the regional settings that firmware uses.</p> <p>US: Starting from the 1st of Jan 2013 FCC regulations state, they will allow transmission on 25 kHz radio channels only if the link rate of the radio is at least 19200 bps. In case Region code is set to US and the active setup violates above mentioned FCC requirement, the radio modem cuts the transmitter power level to zero (0 W) when transmitting. The radio modem is ensuring it is operating according to the FCC requirement. Default value: No regional settings defined.</p>
Routing	<p>See the chapter MESSAGE ROUTING Default value: Routing mode OFF</p>
Customer Info 1	<p>Any arbitrary text (max. 32 characters) can be saved in the setting for identification purposes etc.</p>
Customer Info 2	<p>Any arbitrary text (max. 32 characters) can be saved in the setting for identification purposes etc.</p>
Customer Info 3	<p>Any arbitrary text (max. 32 characters) can be saved in the setting for identification purposes etc.</p>

Note**) Supported serial port parameters: 7N2, 7E1, 7E2, 7O1, 7O2

9. SL COMMANDS

9.1 Changing parameters using the SL COMMANDS

The controlling terminal device can change the configuration settings of the module. This is accomplished with the help of SL commands. SL commands can be used to change e.g. the frequency or addresses. It is also possible to ask the radio transceiver module to show current settings which are in use. The terminal device is either a PC or a programmable logic (PLC) together with suitable (terminal) program. SL commands must be enabled using *Programming Mode* before they can be used.

An SL command is a continuous string of characters, which is separated from other data by pauses which are equal or greater than time defined by Pause length parameter (default=5 characters) in the set-up. No extra characters are allowed at the end of an SL command. Serial interface settings are the same as in data transfer and pin 12 of the serial connector **MUST NOT** be connected to ground (GND). SL command is properly recognised also in the case when the command string is terminated in <CR> (=ASCII character no. 13, Carriage Return, 0x0d) or <CR><LF> (<LF> = ASCII char. no. 10, Line Feed, 0x0a). Pause according to set Pause Length - parameter is required also in this case. If multiple SL commands are sent to the radio modem the next command can be given after receiving the response ("Ok" or "Error") of the proceeding command. In addition, it is recommended to implement a timeout to the terminal software for recovering the case when no response is received from the radio modem. When the power of a radio modem is switched off the configuration settings of a radio modem always return to values defined initially using the Programming Mode, thus resetting any settings changed using SL commands during power on. It is however possible to save settings changed by using SL commands and to make them the new configuration settings.

CR/LF characters are added to end the response messages (unless they are already present) in order to make parsing easier. Settings can be toggled, SL Commands ON/OFF, CR/LF ON/OFF. Note: SL commands work in the command mode always independent from the setting.

The radio modem will acknowledge all commands by returning an "**OK**" (command carried out or accepted) or the requested value, or an "**ERROR**" (command not carried out or interpreted as erroneous) message. SL command response time depends on the used command. Typical response time is ~100ms and upwards. Recommended safe timeout for SL command response is 500ms.

To get information of the latest and/or special SL commands please contact SATEL or local SATEL distributor: <https://www.satel.com/where-to-buy/>.

9.2 Command Mode

Command mode purpose is separate device normal condition from configure condition. When command mode is active, device is looking for known commands from serial interface data. Command mode enables forcibly the SL command mode and disables the radio interface functions (Tx/Rx).

9.2.1 Entering to command mode

Entering to command mode is performed when device gets three (3) '+' characters in a row. Between characters needs to be a delay of pause length. In this way device can decide that it is required to enter command mode after three correct characters. First two (2) '+' –characters is transmitted by radio, because device cannot know at this point whether the last character is correct. After successfully given command mode entering syntax, device responds "OK<CR><LF>". Below is a figure to entering command mode.

+ <pause length> + <pause length> +

Delay between characters depends on what is the current serial baud rate. See specifications of three (3) character delays below in "Table 1. Delay in different baud rates".

9.2.2 Return to data mode

When command mode is active, it is possible to return in normal data mode by giving three (3) '-' characters in a row. Sequence is same as entering to command mode, so there is also needed the delay of pause length between sending the characters. After successfully given exit command mode syntax, device responds "OK<CR><LF>". Below is a description how to exit command mode.

- <pause length> - <pause length> -

Delay between characters depends on what is the current serial baud rate and pause length setting. See example of delays below in Table. Delays in different baud rates", when e.g., pause length setting is set to three.

Baudrate	3 Character delay [ms]
9600 bps	3.13
19200 bps	1.57
38400 bps	0.79
57600 bps	0.52
115200 bps	0.26

Table 1. Delays in different baud rates

10. CHANNEL LIST

A list of predefined radio channels can be stored in the memory in order to change the radio settings simply by switching between the channels.

Channel lists can be created and utilized by using either SATEL NETCO DEVICE software tool or SL commands. It is possible to use the Channel List -feature in relations to “LCD Mode” options in the devices that are equipped with LCD user interface. Please see chapter “Display and push buttons” for additional information. After Channel List is enabled and channel set defined, it is possible to configure radio parameters via LCD UI & function buttons only according to the pre-set Channel List frequencies and channel spacing (and possible TX Power limitations).

Each “Channel List” channel carries the following info:

- Channel number. Unique number for each channel (-32767...32767)
- Transmitter/Receiver frequency
- Channel width (12.5, 20 or 25 kHz)
- Transmitter power level (Max. TX power level, optional)

Additionally, the default channel that the radio modem uses after a reset is defined. Up to 40 channels can be defined.

SATEL NETCO DEVICE software provides Channel List parameters (snapshot below) for creating and saving a channel list into the radio modem, or in a file for later usage.

Entering to the Channel List -feature parameters require elevated access level to software tool. Please contact SATEL or local SATEL distributor for additional information:

<https://www.satel.com/where-to-buy/>.

SL commands provide an interface for a host device to command the radio modem directly. An example of the procedure for creating or replacing a channel list:

1. Clear existing channel list (SL\$C=0)
2. Set channel info for each of the channels to be created starting from index 0 (SL\$L=)
3. Set number of channels in channel list (SL\$C=)
4. Set the default channel (SL\$D=)
5. Verify the new configuration:
 - Get number of channels in channel list (SL\$C?)
 - Get channel info for each of the channels (SL\$L?)
 - Get the default channel (SL\$C?)
7. Enable Channel list (SL\$M=1) in order to activate the Channel list
8. Save the settings (SL**>)

11. REPEATER MODE AND ADDRESSING

Repeaters and addressing may be used to extend the coverage area of a radio modem network, and to direct messages to selected radio modems in the network. In large systems, with several repeaters and formed repeater chains, it is often practical to use routing instead of plain addresses.

11.1 Repeater

In circumstances where it is necessary to extend the coverage area of a radio modem network, SATEL-EASy Pro+ radios can be used as repeater stations.

The maximum size of a repeated data packet is 1 kB (kilobyte). The *Repeater Function* is switched on using NETCO DEVICE, SL commands or the LCD menu. In the repeater mode the radio modem will function as a totally independent unit, which means that only a power supply and a suitable antenna are needed. Other devices are not necessary.

A radio modem acting as a repeater can also be used to receive and transmit data. In repeater mode the radio modem will transmit the received data to the serial interface in a normal fashion. The difference being that the received data will be buffered into the buffer memory. After reception the radio modem will re-transmit the buffered data using the same radio channel as in reception. Data received through the serial interface a radio modem in repeater mode will transmit normally.

The same network may include several repeaters, which operate under the same base station. Repeaters may also be chained; in which case a message is transmitted through several repeaters. In systems with more than one serially or parallelly chained repeater, addressing or routing protocol must be used to prevent a message ending up in a loop formed by repeaters, and to ensure that the message finally reaches only the intended radio modem.

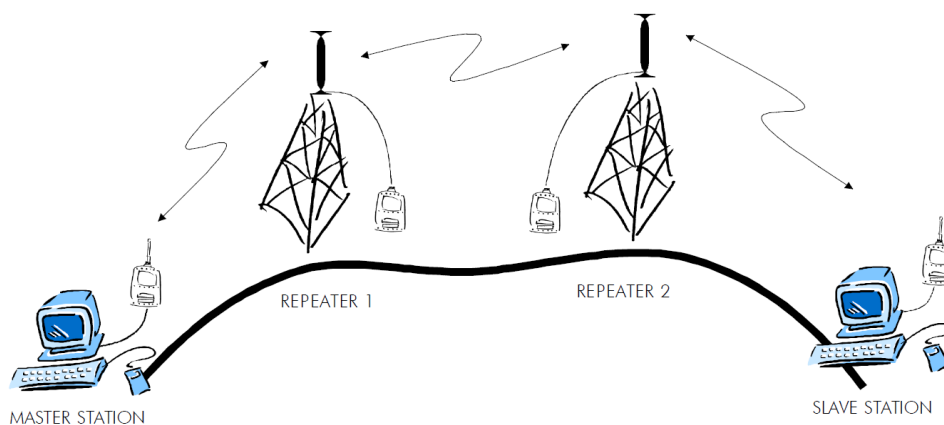

11.2 Addressing

Addresses can be used to route a data message to the desired destination or to separate two parallel networks from each other. In networks with repeaters it is usually necessary to use addresses to prevent data messages from ending up in loops formed by repeaters. In case of setting the “Message Routing” function in use, Tx / Rx addresses are ignored by the modem.

This feature is designed for SATELLINE-3AS, SATEL-8FSK-1, SATEL-8FSK-2 and SATEL-16FSK-1 – radio compatibility modes.

SATEL-EASy Pro+ allows the use of individual addresses both for reception and transmission. Addresses can be switched on separately, or simultaneously, in both data transfer directions.

The radio modem contains two transmission and two reception addresses, which are known as the primary address and secondary address. The primary address is used whenever data from the serial interface is transmitted. At the receiving end, the radio modem will receive using either of the two receive addresses.

Secondary transmit address is only used in repeater applications.

Radio modems configured to function as repeaters, will repeat data messages using either the primary or secondary address, depending upon which address was used during the reception of the data message.

If only one address pair is needed in a network, both addresses must be set the same (TX1 = TX2 and RX1 = RX2).

It is also possible to transfer the received address onto the serial interface.

The address is composed of two characters totalling 16 bits, resulting in over 65,000 different address combinations. The address is attached to the beginning of each data packet sent by the radio modem. When a radio modem receives a data packet whilst using addressing mode, the radio modem will check the first two characters of each received data packet to ensure that the packet in question was intended for the correct radio modem.

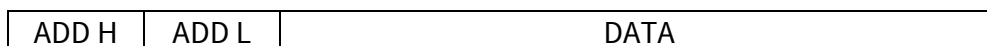

Address may be selected between 0000h...FFFFh (h = hexadecimal, corresponding decimal numbers are 0-65535).

Example: address 1234h (4660 in decimal format), where 12h is ADD H and 34h is ADD L.

Example: address ABFFh (44031 in decimal format), where ABh is ADD H and FFh is ADD L.

Transmission:

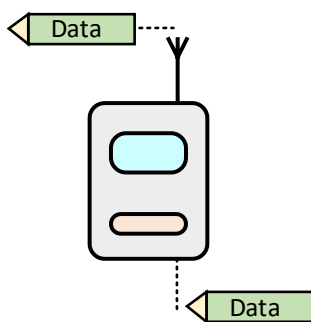

Transmission address has been set OFF.
Radio modem will transmit the data packet
as such.

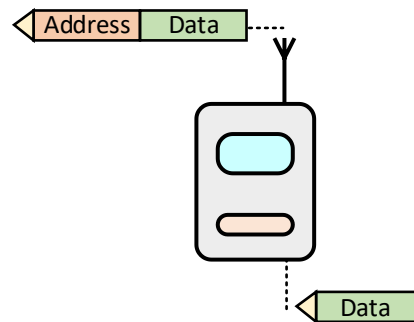

Transmission addressing has been set ON.
The radio modem will add the primary TX
address to the beginning of the data packet.

Reception:

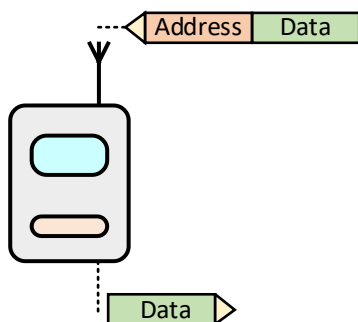

Reception addressing has been set ON and
either the primary or secondary RX address of
the radio modem is identical to the address of
the received data packet.

The radio modem will remove the address and
send the actual data to the RS-232 interface.

However, if the "RX Address to RD-line" setting
is on, the radio modem does not remove the
address.

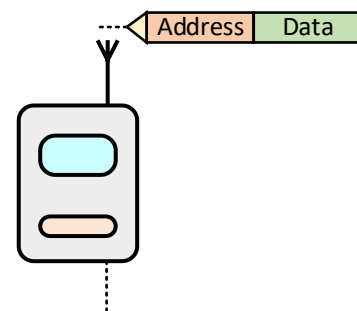

Reception addressing has been set ON, but
both the primary and secondary RX addresses of
the radio modem are different from the
address of the received data packet.

Data does not appear on the RS-232 -
interface.

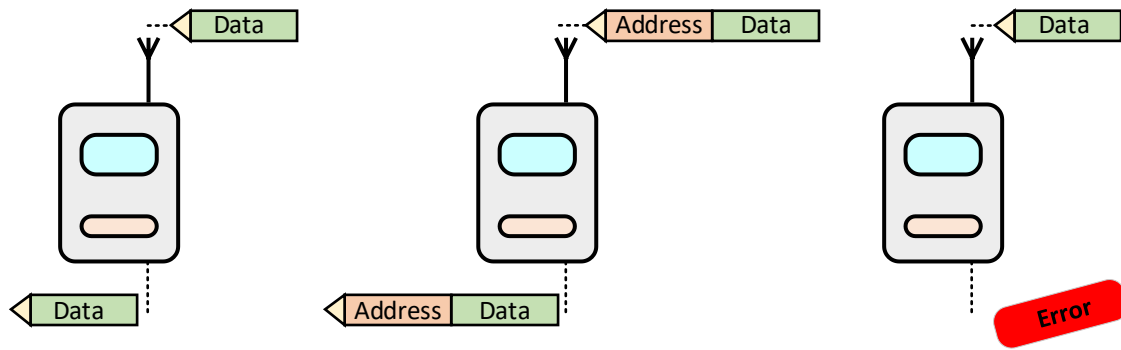

Reception addressing has been set OFF.

The radio modem will transfer all received data to the RS-232 interface.

Reception addressing has been set OFF.

The radio modem will consider the characters of the address as a part of the data and will send all the characters to the RS-232 interface.

Reception addressing has been set ON but there is no address in the data packet.

Data will appear on the RS-232 interface ONLY if the first 2 characters of the data match either of its own RX address. The radio modem will remove those 2 characters of data.

11.2.1 Connection between two points

When forming a connection between two points it is recommended that both the reception and transmission addresses are identical in both radio modems. This is the easiest way to control addresses and the risk caused by interference from other systems operating in the same area is minimal.

Example: by setting all addresses of both radio modems to a value '1234', they will accept only those messages which contain this address, and they will use this same value when transmitting data.

If the channel is reserved for use only by the said network, or if the terminal devices are responsible for addressing, it is not necessary to use addressing in the radio modems.

11.2.2 System of one base station and several substations

In systems with several substations, the base station must know to which substation each message is intended, and from which substation each received message originates. Usually terminal devices handle addressing completely, but it is also possible to use the addressing functionality of the radio modems.

For example, if the substation terminal devices are not able to check and form addresses by themselves, addressing may be achieved with the help of the addresses of the radio modems attached to these terminal devices. The base station may, in such a case, define the destination of

a message by adding the address of the corresponding radio modem into the beginning of the data packet. The substation radio modem(s) will check the address and the corresponding radio modem will identify and remove the address characters. In a similar way, the substation will add when transmitting to the base station its address characters into the beginning of the data packet, thus defining the origin of the sent data packet. In the base station radio modem, addresses have been switched OFF, so that they are transmitted as is to the base station terminal device for further processing.

11.3 Using repeaters and addresses in the same system

In systems with several repeaters, a substation and a base-station, addresses must be used in radio modems. It is possible to realise also a system with only one repeater without addressing. In such a case, the base station will however hear the message both from the substation and from the repeater, in other words the message is duplicated as it moves along the route.

There are at least two ways of realising such a system depending on the capabilities of the terminal devices in question and on the number of repeaters to be used and on their relative positions to each other.

11.3.1 System with several repeaters

In systems with several serial or parallel-chained repeaters, addressing must be used to prevent messages from ending up in loops otherwise formed by repeaters, and to ensure that only the desired (addressed) radio modem receives the data intended for it.

All radio modems in the network must be set to a state, in which the RX-addressing is switched ON and TX-addressing is switched OFF. Base-station and all substations add an address string in the beginning of the data to be transmitted. In the relaying of the message addressing is used in the following way:

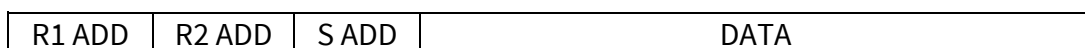

- The above is the data received from the base station terminal device, containing repeater addresses (R1 ADD, R2 ADD) and the substation address (S ADD). Two characters define each address.

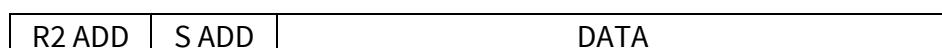

- The above is the same message after being relayed from repeater 1 to repeater 2.

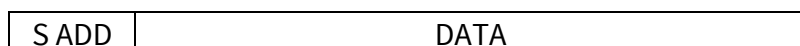

- The above is the same message after being relayed from the last repeater in the chain (repeater 2) to the substation.



- The above is the same message being relayed via the serial interface of the substation radio modem to the terminal device.

In a situation where the substation transmits data towards the base-station the address is formed in a similar way, but the order of the addresses is reversed:

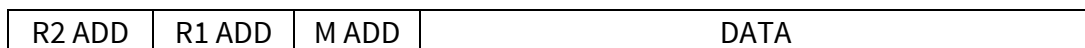

-In the above, R2 ADD is address of repeater 2, R1 ADD is address of repeater 1 and M ADD is the address of the base-station.

11.3.2 Repeater chain using address pairs

In a situation where the terminal devices and substations cannot form address fields, but are able to recognise messages addressed to them, alternating address pairs may be used. Transmit address (TX) and receive address (RX) alternate in the order shown in the table below.

Address type	Base-station address	Repeater 1 and the addresses of the substations of the base-station	Repeater 1 substations addresses
TX-address	Address 1	Address 2	Address 1
RX-address	Address 2	Address 1	Address 2

In a network where alternating addresses are utilised, the exact route that is used to relay a message to a certain radio modem is fixed at the time of installation and configuring the system. The order of the addresses must be the same as the order of the route that is used to relay the message to the said radio modem. It should be noted however, that in network where alternating addresses are used the base-station and substations will hear their own messages repeated.

11.3.3 Repeater chain using dual addressing

If the terminal devices cannot add address chains to the beginning of the data packets, a network with several repeaters may still be realised by using dual addressing. In dual addressing each link (see arrows below in figure) is given a unique address, which will prevent duplication of messages and endless loops in the network. The terminal devices need not add anything to the data.

Usually the primary transmit address is used in transmission (TX1). The secondary transmit address (TX2) is used only if the *Repeater Mode* is used and the packet to be repeated was received using the secondary reception address (RX2).

In the following example two repeaters are used. It should be noted that each link (arrow) might be uniquely defined with the help of radio modem numbers and data transfer directions. The *Repeater Mode* should be switched ON only in the radio modems acting as repeaters to prevent the packets from remaining in endless loops in the network.

Repeaters may also act as ordinary substations; in that case the terminal device must wait until the message has reached the end of the repeater chain before sending data.

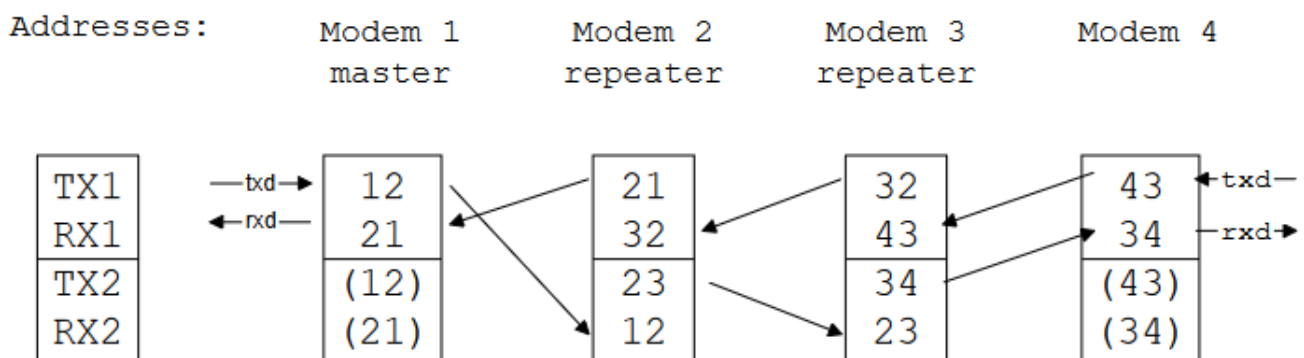

11.3.4 Redundant repeater chain

Reliability of a radio data communication system can be improved significantly by designing redundant equipment setup for master and repeater stations. The two repeater chains are separated by proper dual addressing setup. Slave stations need to be able to communicate with the master through the both repeater chains. By using the "TX address auto switch" function, the slave station modem directs the reply message to the repeater chain from which the request has been received.

If "TX address auto switch" has been set ON, radio modem checks out the RX address of the received message. When one of the RX addresses is recognised, all the messages coming in from the serial interface will be sent to the air with matching TX address. The use of "TX address auto switch" function is not recommended if Repeater Function is set ON.

12. MESSAGE ROUTING

12.1 Introduction to Message Routing

Message Routing is an exciting feature in SATEL-EASy Pro+. This feature allows messages from terminal devices to be automatically routed over the radio modem network to a specified recipient terminal.

In brief, the *Message Routing* works as follows:

- First, a radio modem reads any message coming from the terminal(s) attached to it.
- The radio modem detects the terminal address of the recipient, by seeking a pre-set position inside the message for the address.
- The radio modem checks its internal route table to see, if there is route information corresponding the address it has just found.
- The radio modem transmits a radio frame, which includes
 - network ID (see separate chapter)
 - route information
 - original user message encapsulated
 - redundant information such as checksums for error checking etc.
- The radio modems along the route relay the frame over the network to the radio modem at the destination.
- The radio modem at the destination first checks the validity of the received radio frame, then extracts the original user message, and finally outputs it the terminal device attached to it.

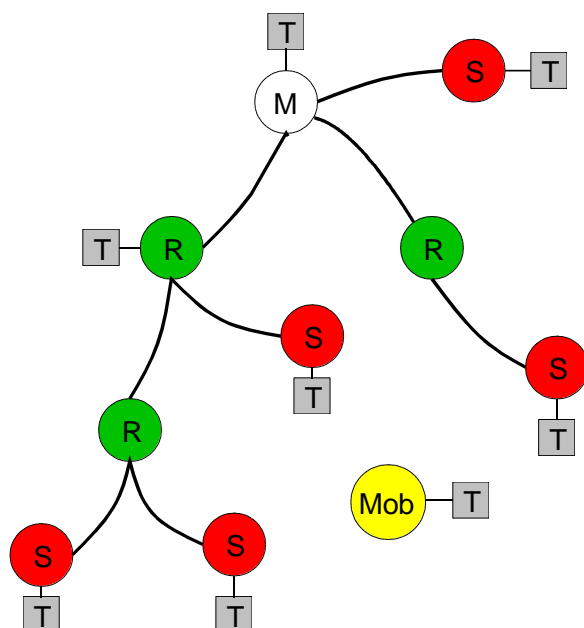

The figure left illustrates a possible structure of a radio modem network.

M = Master station (Central station)

R = Repeater station

S = Slave station

T = Terminal device

Mob = Mobile terminal

Terminals are usually PLC devices that send and receive messages according to a specific user protocol.

Note: The term *repeater* used in the context of the *Message Routing* should not be mixed with the *Repeater Mode*, which is a feature independent from the *Message Routing*.

12.1.1 Features of Message Routing

The *Message Routing* feature of the SATEL-EASy Pro+ is designed to be a fast and transparent to fit real time systems. The features include:

- Transparent to user protocols.
- Easy construction of a network containing several repeaters.
- Any radio modem may operate as a repeater, i.e. dedicated repeaters are not usually needed thus cutting down on costs.
- Large areas of coverage may be implemented by using only one radio channel.
- The use of mobile substations is also possible to some extent.
- The system will be fully deterministic i.e. the transmission delays are predictable. Because of that, the principle of *Message Routing* is connectionless.
- Added redundancy as a failing radio modem can be, in certain cases, bypassed with another radio modem positioned in the same coverage area (repeater stations over-hop functionality for dynamic network changes).
- *Message Routing* is intended mainly for the protocols based on polling scheme and a single master station.
- *Message Routing* offers offline monitoring for the radio network RF link health (RSSI).
- *Message Routing* is available in "SATELLINE-3AS" radio compatibility mode. Compatible also with the widely used SATELLINE-3AS and SATELLINE-EASy radio modem families.

12.1.2 Limitations of Message Routing

- It is assumed that the position of the address field in the user messages is fixed. However some special protocols are supported:
 - IEC 60870-5-101 is a protocol commonly used in control applications of power lines.
 - RP570/571 protocols
- The message cannot end to the address; there must be at least one character after the address.
- It is assumed that there is only one message at a time inside the network simultaneous messages could cause collisions.
- Up to 100 remotes, max. 16 hops.
- Operation of the Tx / Rx addresses is automatically blocked in the case of switching the "Message Routing" function on.

12.1.3 Configuration of the Message Routing

The design of any radio modem system requires very precise planning. Once the choices between devices, their location, installation, maintenance etc. are clear, the *Message Routing* for the system can be implemented.

SATEL NETCO DESIGN and SATELLINE SaTerm are a PC SW tools that allows the user to design their required network simply and quickly using a graphical interface to literally draw the network plan on the screen.

- Firstly, a picture of the network is created to show all the radio modems and the intended route that the data is to take.
- Secondly, the required settings are defined in the SW view.
- Finally, the setup of each actual radio modem can be uploaded by connecting the actual radio modems one by one to the COM port to synchronize the radio parameters from SW tool to each radio separately.

Please check the user manuals of *SATEL NETCO DESIGN* and/or *SATELLINE SaTerm* for more details: <https://www.satel.com/support-and-services/downloads/>.

Additional information available from local SATEL distributors and SATEL technical support.

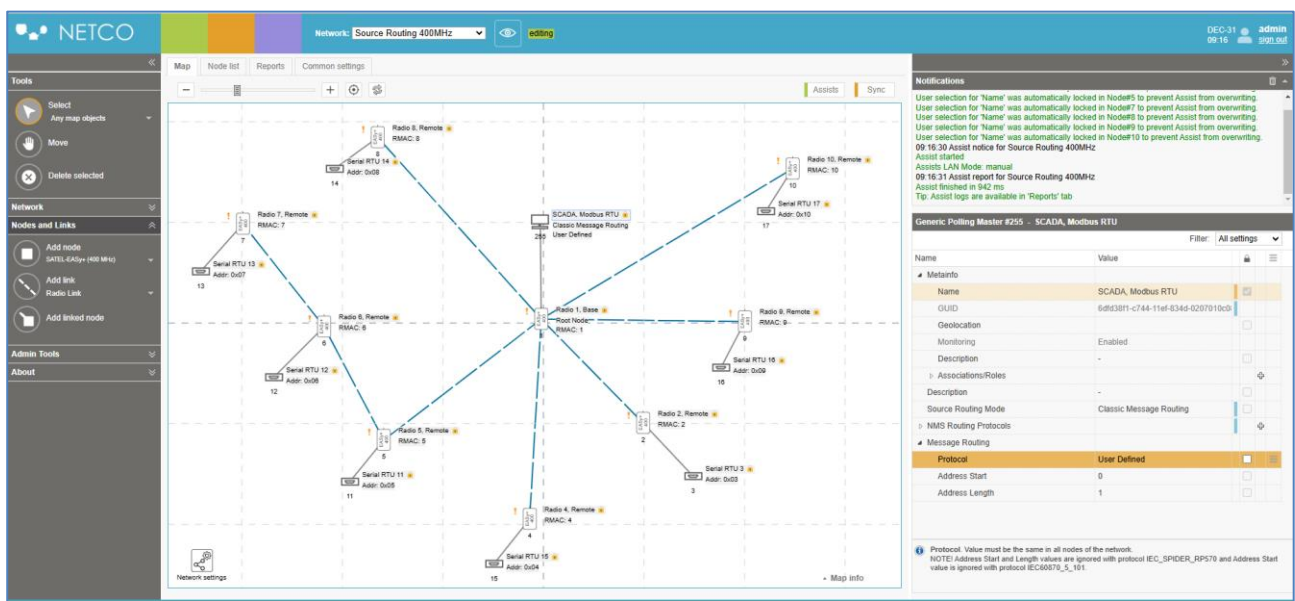

Figure 12.1.4a, SATEL NETCO DESIGN SW tool, map view.

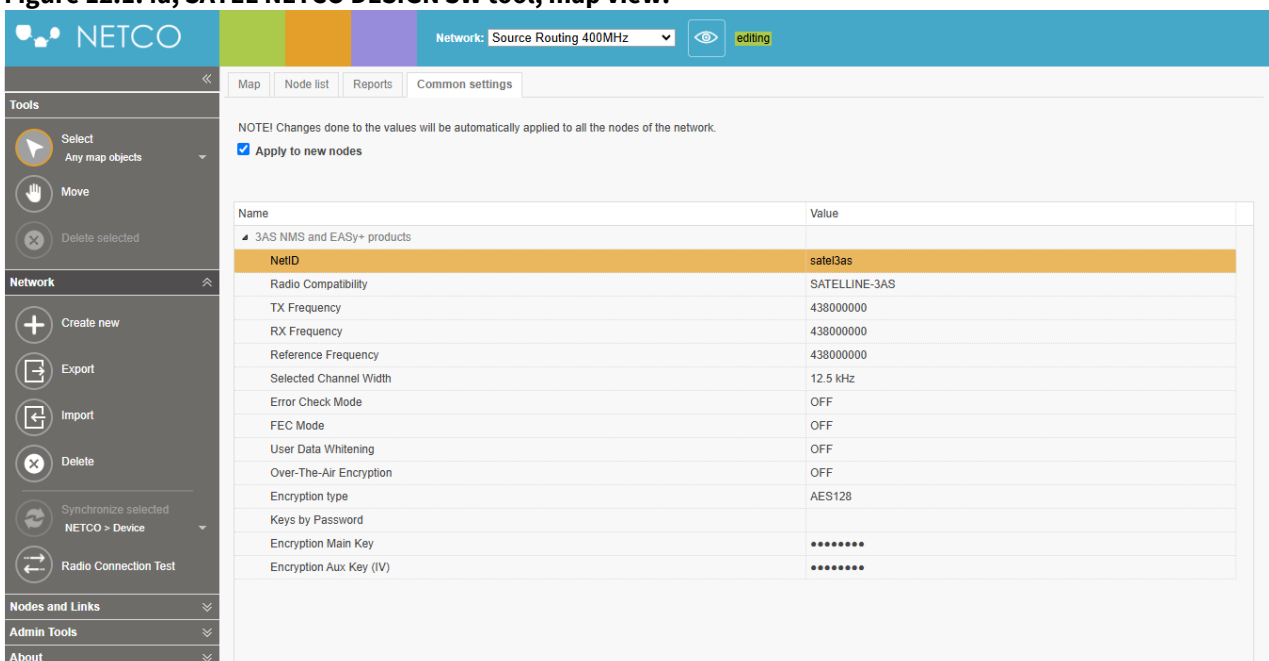

Figure 12.1.4b, SATEL NETCO DESIGN SW tool, “Common settings” tab for radio critical parameters.

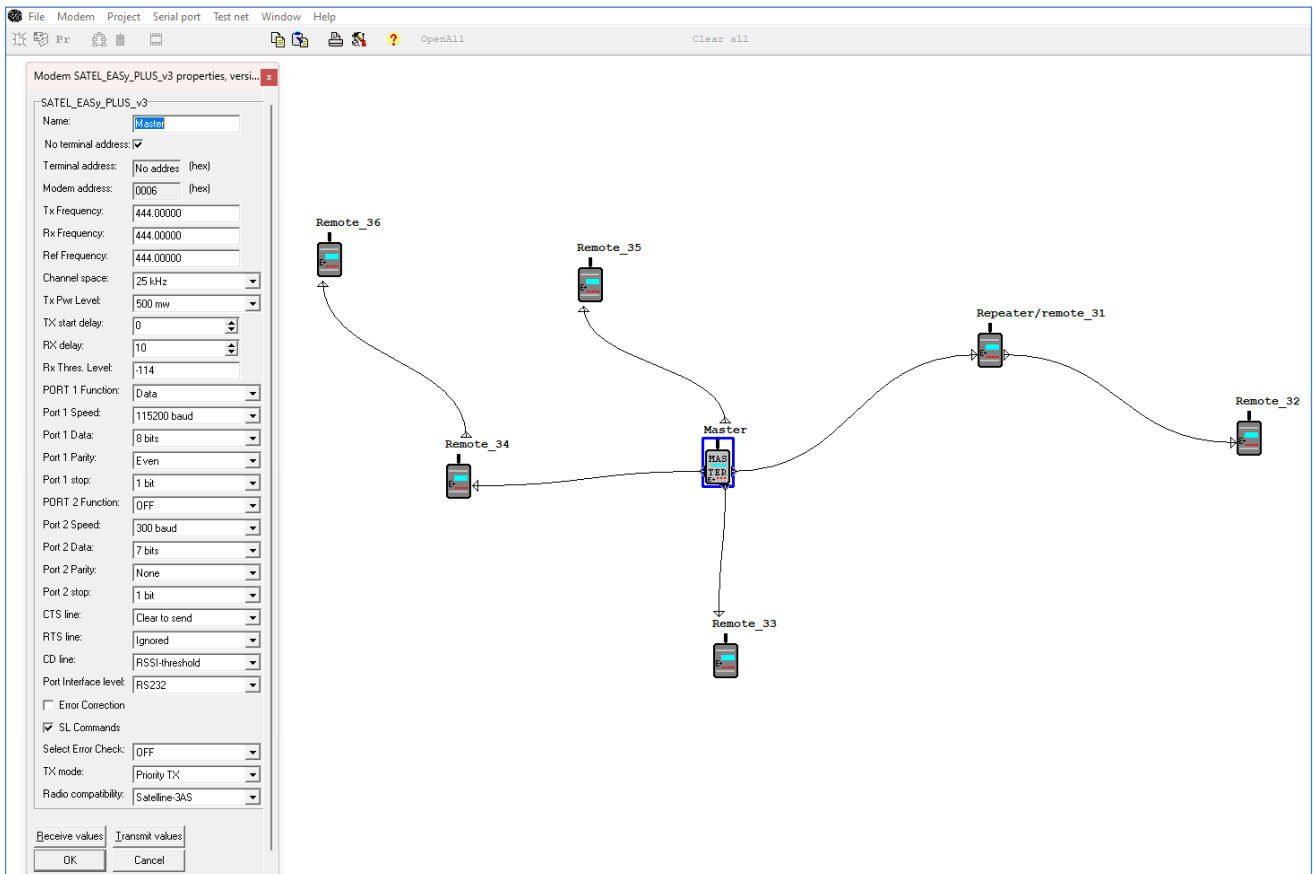

Figure 12.1.4c, SATELLINE SaTerm SW tool, map view.

12.1.4 Configuration of the protocol in Message Routing

A radio modem will detect the presence of an address used by inspecting the protocol from the message received via the serial interface. On the basis of this user address, all necessary information needed to relay the message to destination is fetched from an internal routing table inside a radio modem. The user protocol is not interpreted; instead, the user address is searched according to its location in the message. The beginning of the packet is located by a preceding pause in the byte stream. Message Routing can therefore be applied to most protocols with fixed address field position.

The position and length of the address is defined by two settings: *Offset* and *Length*.

- Offset defines the number of bytes (0...15) preceding the address.
- Length is the length of the address in the user protocol expressed in bytes (1...4).

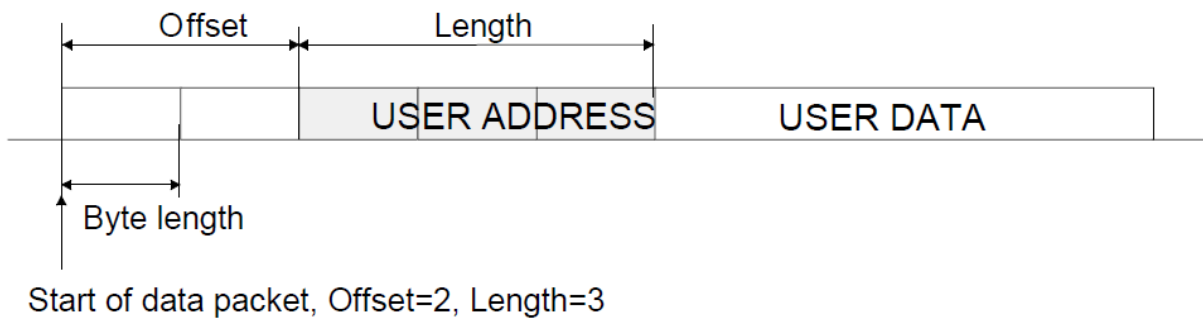

A transmitting radio modem adds a routing header and a tail to the user message. Consequently, a radio modem that receives the message removes the header and tail - so the Message Routing scheme is transparent to the user protocol.

12.2 Detailed description of Source Routing

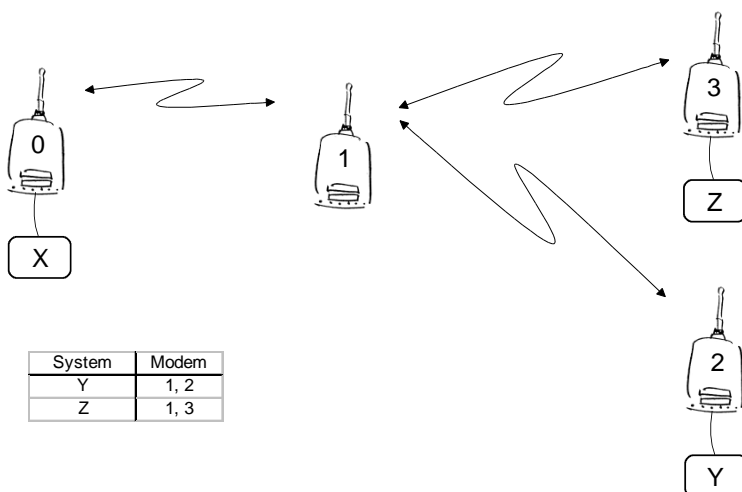

The above figure represents a network containing four (4) radio modems. Each radio modem is given a unique address (0...3). A terminal device has been attached to the three of the four radio modems and they communicate with each other using terminal addresses X, Y and Z, respectively. Radio modem 0 and terminal device X together constitute the base station of the network and all routing information of the network has been programmed into this base station.

When the terminal device X transmits a packet to (e.g.) terminal Y, radio modem 0 will detect the address Y from the data received through the serial port. From the routing table a route 1,2 can be found to which the radio modem also adds its own address to define the route for return data. Radio modem 1 repeats the packet and radio modem 2 removes the address information from the received data packet thereby transferring only the original data to the serial interface. The address information received together with the packet is reversed (2, 1, 0) and saved to be use in the transmission of subsequent reply packets.

12.2.1 Over-hop function in Source Routing

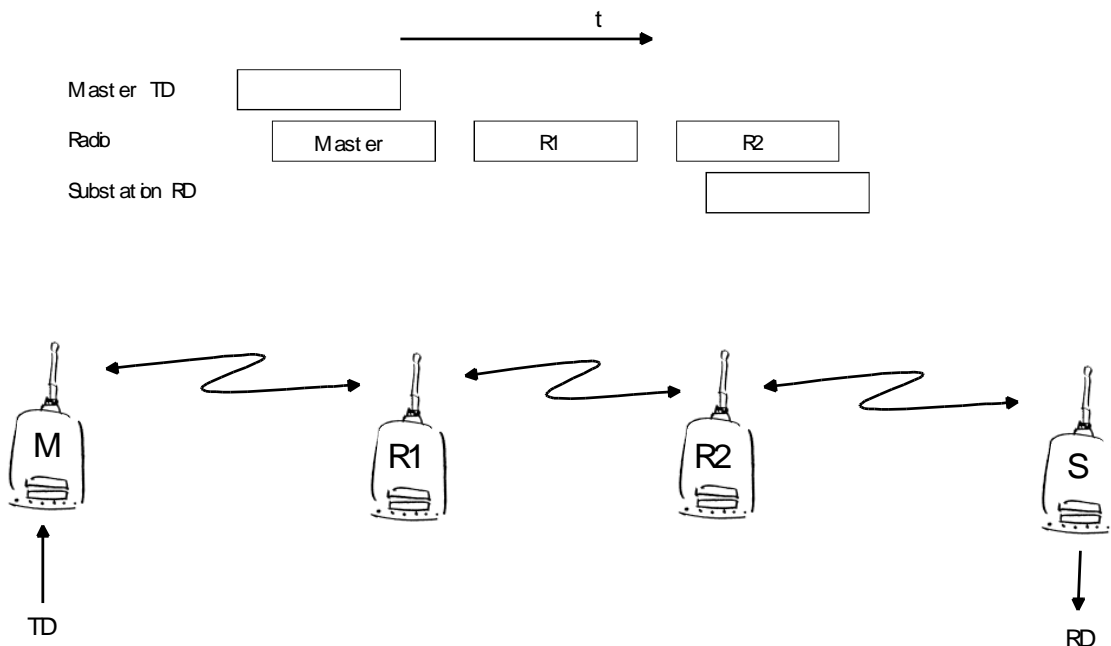

When using repeaters, the same packet is sent via a (radio) channel several times. A radio modem situated in the repeater chain will often hear other radio modems in addition to the immediate neighbouring radio modems. With *Source Mode Routing* the complete address information is sent together with the packets enabling the use of these secondary routes. Usually repeaters have better antennas (and/or antennas placed higher) than normal substations, which means that the distance between two repeaters can be much longer than the distance between a repeater and a substation.

Connections to other than the neighbouring stations of the repeater are not necessarily reliable under all possible (radio) conditions, but they can often be used to keep the network up and running at least partially should a repeater somewhere in the middle of the chain fail. In addition to this, the likelihood of a transmission error decreases if it is possible to listen to more than one transmission since; in this case, it is more likely that at least one of them will be received error-free. It is also possible, that the radio connection is asymmetrical due to the greater output power of a repeater or due to local interference, in which case, data can in fact travel in opposite directions using different routes.

When a repeater receives a message that contains its address but not as the first address in the address field, the packet is stored in a buffer. If the relayed message from the repeater, and the modem having sent the message originally, is not received (due for example, because of radio modem failure or if it has an erroneous checksum), the packet already buffered into the memory is re-sent without any change to the timing (no additional delays are introduced). Because of this, relatively short hop distances can be used, without the likelihood of errors being increasing due to the added number of repeats. A possible error in one of the repeaters does not necessarily cause a total breakdown of traffic.

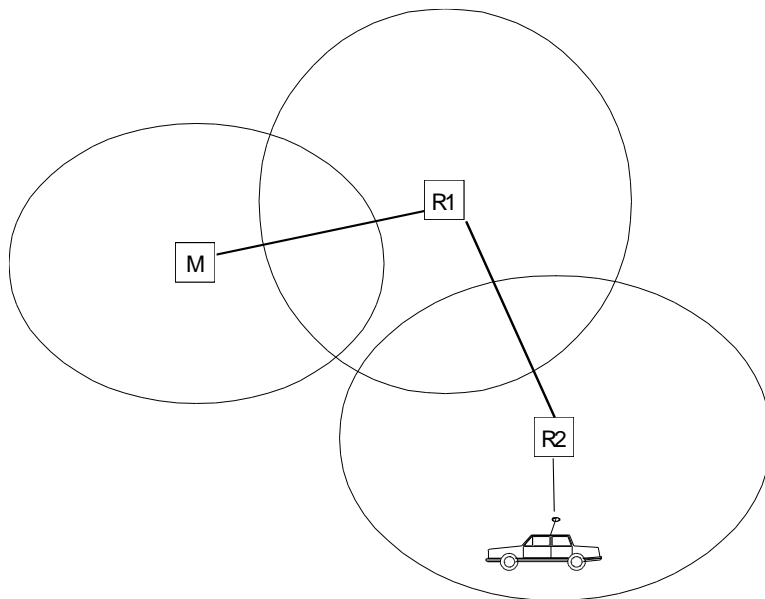

The over-hop function allows for the use of mobile substations. In the example above, a mobile substation is first located in the coverage area of repeater R2. The route is defined as M, R1, R2 and vehicle. When the vehicle moves to the coverage area of repeater R1, the radio modem picks the packet already from the transmission of R1. This is then transferred to the serial port using an additional delay, so that the timing does not differ from the first situation where the radio modem of the vehicle was in the coverage area of repeater R2. In this way a collision of the reply transmission and the transmission by repeater R2 is prevented. When the mobile station is transmitting, it is enough that at least one radio modem defined to be a part of the route receives the transmission.

12.2.2 Network ID

The Network ID is a string of up to eight characters, which is used to prevent the reception of the messages coming from an external system. The radio modems operating in the same system using *Message Routing* must have the same Network ID. Only the messages that have a matching Network ID are received.

13. NMS Network Management System

The purpose of the NMS (Network Monitoring System) is to provide tools for management of a radio network built on SATEL-EASy Pro+ radio modems. NMS allows user to manage, monitor, diagnose and configure SATEL-EASy Pro+ modem network remotely without disturbing user's data flow.

This chapter includes a very short description of SATEL NMS for SATEL-EASy+ radio modem family. More information is provided by the SATEL NETCO NMS and SATEL NMS PC user manuals and application notes.

13.1 System components

SATEL NMS consists of:

- SATEL NETCO NMS or SATEL NMS PC program. The program provides the user interface showing the status of the network:
 - Graphical network overview
 - Sort able lists of all modems and radio links
 - Link quality tests and monitoring
 - Alarms generated on link failure, operating voltage drop etc.
 - Remote administration of modem parameters
 - Log files
- The diagnostic functions in the SATEL-EASy Pro+ radio modem software. The set of features depends on the hardware and software version of the radio modem.
 - One of the modems operates as the *Master modem* of the system (*Network Mode* parameter of the radio modem set to *Advanced - Master*).
 - The other modems are the *substations* of the network (*Network Mode* parameter of the substation radio modems set to *Advanced - Slave*).

13.2 NMS – Installation

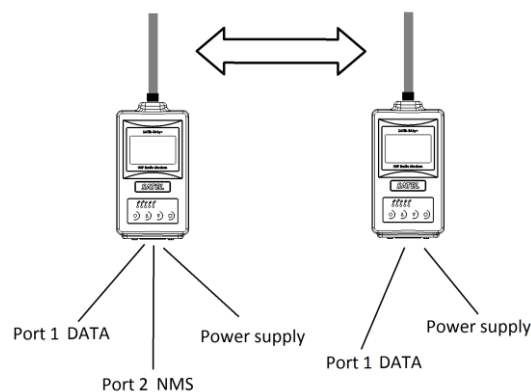

Figure 13.2 SATEL-EASy Pro+ basic NMS set up

SATEL-EASy Pro+ radio modem models with two serial ports are intended for NMS networks. Two port models are required at minimum in base radio stations. One of the ports is configured as the DATA port (by default *Port1*) that is connected to the user application. The other port is the NMS port (by default *Port2*) that is connected to the serial port of the PC running SATEL NETCO NMS or SATEL NMS PC software.

13.1 How to add SATEL-EASy Pro+ to SATELLINE-3AS NMS network in SATEL NMS PC

Since the SATEL-EASy Pro+ factory settings (serial port as well as the radio settings) are always the same, those should be set first as in the existing radio network to avoid conflicts.

Adding a new SATEL-EASy Pro+ modem to SATELLINE-3AS NMS network:

Due to the settings of the SATEL-EASy Pro+ modem, the new modem to network must be add in the SATEL NMS PC software Design menu with the function “Add modem using hardware” and then follow the requests in the to-do list.

Before this operation, it is recommended to check and adjust radio settings of the new SATEL-EASy Pro+, e.g., channel width (spacing), frequency, FEC status.

As the default serial baud rate of SATELLINE-3AS NMS diagnostics port (port 2) is 9600 bps, it is recommended to use the same baud rate also with SATEL-EASy Pro+ when adding it to an existing 3AS NMS radio network. When using this baud rate, the serial server advanced settings timeout must be set to 10000 ms. Otherwise, the connection between NMS PC and SATEL-EASy Pro+ does not work properly.

When creating a new network with SATEL-EASy Pro+, NMS port baud rate can be used 115200 bps. In this case the serial server timeout recommendation is 6000 ms.

13.2 NMS - Usage

SATEL NETCO NMS and SATEL NMS PC software provide the user interface to NMS system. Refer to SATEL NETCO NMS and SATEL NMS PC User Guide for additional information.

13.3 NMS functionality

SATEL NMS provides useful tools for maintaining the radio network. The following functions are included in the SATEL NMS system:

- Status of the network can be obtained easily. Received Signal strength (RSSI) information, Voltage, Temperature and quality of the radio links can be monitored

without disturbing user's data flow. SATEL NETCO NMS and SATEL NMS PC software collect statistics on the radio modems of the network.

- Alarms (triggered e.g. by a significant decrease in signal level of a radio link) are generated for the external system usage.
- The history of the parameters is saved to log files for later examination.
- Remote update of the setup i.e. the settings of a radio modem.
- Data communication tests. A full data communication test can be run to find out more detailed analysis of each radio link. Whenever needed this test indicate profoundly the quality of the radio communication.

SATEL NMS system is subject to continuous development - new features will be introduced to respond actual customer needs. The radio modems have a comprehensive interface structure that enables even more complex functions to be added to SATEL NETCO NMS or SATEL NMS PC while radio modem needs to manage only a limited set of tasks.

13.4 Requirements for the user system

SATEL NMS fits the systems that are:

- Single master systems with point-to-multipoint network structure
- Based on polling protocol (the master polls the remotes regularly)
- Transferring user messages not larger than 1kByte

Other kinds of systems may also be possible but require careful consideration; in such cases the customer is advised to contact SATEL for more information.

Repeater stations are fully supported. While operating the monitoring system, radio data links are transparent. Because NMS data is invisible to the user's system, most user protocols are not interfered by NMS. However, note that on-line NMS always affect the real time operation of any system due to the extra information transferred. In some cases, this means that the parameter defining the timeout of the slave station reply must be increased. Depending on how much NMS information is required, NMS introduces an extra load of ~20...60 bytes per a message.

13.5 Designing Systems and Networks

The Routing window of SATEL NETCO NMS or SATEL NMS PC software provides a graphical tool for designing the radio network. It is used by simply dragging and dropping modem icons on the sheet and linking the modems and finally uploading these settings to individual modems.

The designing of any radio modem system requires very precise planning. Once the choices between devices, their locations, installation, maintenance etc. are clear, the project file for the system can be implemented by using SATEL NETCO NMS or SATEL NMS PC software tools. Please refer SW tools user manuals for more detailed description.

Please visit SATEL WEB pages for additional information:

<https://www.satel.com/products/software/>

Or contact SATEL technical support.

14. SOFTWARE FEATURE EXTENSIONS

SATEL-EASy Pro+ can be upgraded with software features which can be released through DRM (Digital Rights Management). This allows the user to select proper functionalities from the functionality list. The following list explains the possible features with detail.

Following features are separately purchased, excluding SATEL NMS Support (YD0403) which is supported by default in SATEL-EASy Pro+:

14.1 AES256 encryption (YD0402)

Provides an opportunity to use stronger over the air encryption.

14.2 SATEL NMS default config (YD0602)

When ordering SATEL-EASy Pro+ radio modem, choosing SATEL NMS default config (YD0602) the default settings of the modem will be changed to SATELLINE-3AS NMS compatible.

15. INSTALLATION

15.1 Installation of a radio data modem

The radio modem should be installed with the installation accessories supplied with the radio modem. Wall mounting brackets are available separately (see appendix C).

NOTE!

When selecting a suitable location for the radio modem it must be ensured that no water can get into the radio modem under any conditions. Direct sunlight is also to be avoided. It is not recommendable to install the radio modem on a strongly vibrating surface. Suitable dampening and/or isolation materials should be used in cases where the installation surface will be subjected to vibration.

15.1.1 Fuse

A proper fuse must be connected in between the radio modem and the power supply. The correct value is 20 A for SATEL-EASy Pro+.

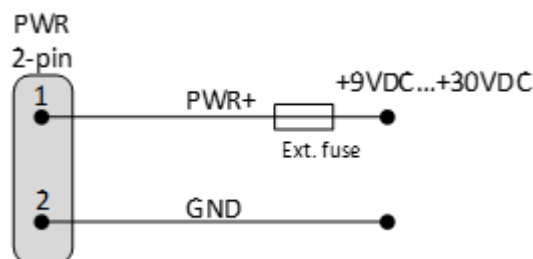

15.1.2 Power supply

The allowed operating voltage is +9 ... +30 VDC. The radio modem must only be connected to a power supply with an adequate current output (power rating minimum is typically 105 W @ +45.4 dBm / 35 W RF output power). The pins 1 and 2 of the 2 pin ODU-connector are connected to the positive power supply (pin 1) line and ground (pin 2) respectively.

EASy Pro+ has an internal reverse polarity protection circuit that ensures that the modem does not damage if the power supply polarity is reversed.

15.2 Antenna installation

NOTE!

Because of the great transmission power of SATEL-EASy Pro+ radio modem, only an external antenna is allowed. A whip-antenna directly connected to the antenna connector must not be used.

15.2.1 Mobile equipment

- ¼-wave antenna
- ½-wave antenna

The ideal installation position is vertical, and there should be at least 0.5 m of free space around the antenna. In small systems a ¼-wave antenna is sufficient. A separate ground plane should be placed under the antenna (vehicle rooftop or the engine hood or trunk door are usually suitable). In problematic cases the most suitable type is a ½-wave antenna. It can be installed directly at the top of a pipe with the added benefit of gaining as much as free space around the antenna as possible. A coaxial cable with 50 ohm impedance must be used between the antenna and the modem's TNC-connector.

15.2.2 Base stations

- Omni-directional antennas (¼-, ½- or 5/8-wave antenna)
- Directional antennas (yagi /multi-element antenna or corner antenna)

The antenna should be installed in a vertical position. The exact location of the antenna depends on several factors, such as the size of the overall system and the coverage area terrain contours. A rule of thumb is that the base station antenna should be located at the highest point of the coverage area and as close to the centre of the coverage area as possible. The base station antenna can also be located inside a building, if the walls of the building do not contain metal.

15.2.3 General antenna installation instructions

The reliability and the achievable coverage of useful signal strength can be severely affected by the positioning of the antenna. Antenna and cable connectors should have gold-plated pins and sockets, as use of low quality connectors can lead to eventual oxidation of the connector surfaces, which in turn may degrade the contact and cause additional attenuation. Good quality tools and materials must be used when installing radio modems, antennas and cables. The weather tolerance of the materials used must also be taken into account. Installed materials

must withstand all foreseeable weather conditions (frost, excess sun, direct UV-radiation, seawater etc.). Also possible environmental pollution must be considered (acids, ozone etc.). Antennas must be installed well away from metallic objects. In the case of small antennas this distance should be at least ½ m. With large antennas the distance should be >5 m and in case of repeater antenna combinations >10 m.

If the system contains a large number of radio modems, the best location for an antenna is the highest point of a building and possibly an additional antenna mast. If a separate antenna mast is used, the antenna can, if necessary, be installed sideways about 2...3 m from the mast itself.

When installing an antenna possible interference sources must be considered. Such interference sources are, for example:

- mobile telephone network base station antennas
- public telephone network base station antennas
- television broadcast antennas
- radio relay antennas
- other radio modem systems
- PC-related devices (approximately 5 m radius from antenna)

When ordering antennas, we request you to note that antennas are always tuned to a specific frequency range. Simple antennas and antennas, which have been constructed of stacked yagi-antennas, are typically rather broadband. As the number of yagi-elements increases the frequency range becomes narrower. Note this specially with 35 W.

When designing and installing a system it is advisable to prepare to test the system, and also to consider serviceability of the system. In particular cabling should be planned to allow easy access and to allow for maintenance. It is often practical to use long antenna cables, so that the radio modem can be installed far enough from the antenna itself to a location that is easily accessible.

The type of the antenna cable is dependent on the length of the antenna cable, and the following table can be used to select a suitable type:

Length	Type	Attenuation 10 m / 450 MHz
<5 m	RG58	3.0 dB
>20 m	ECOFLEX10	0.9 dB
>20 m	ECOFLEX15	0.6 dB

If there is a line-of-sight path between the antennas a 6 dB power marginal is usually adequate. However, if the connection is built on the reflection and/or the knife-edge diffraction the path loss can vary even 20 dB depending on the weather conditions. In this case a short test can give a too positive result of the quality of the connection. Thus the height of the antennas and topographical obstacles must be surveyed with great care. From time to time a marginal

connection can be used if the data transmission protocol is well prepared for this and the data transmission that occasionally slows down does not cause any problems to the system.

Vertical polarised antennas (antenna elements are in vertical position) are often used in radio systems. In a system between a base station and substations vertical polarisation is recommended. The radio modem antenna cannot be mounted on the same level as the other substation antennas in the same building. The best way to distinguish from the other antennas situated in the neighbourhood is to mount the antennas as far as possible from each other on the altitude level. The best result is generally obtained when all the antennas are in the same mast. With an extra ground plane between the antennas more distinction can be obtained between the antennas in the mast.

Horizontal polarisation can be used in data transmission between two points. With the polarisation attenuation more distinction is obtained to vertical polarised systems. The influence of the directional patterns of the antennas must, however, be taken into consideration. If a distinction to another interfering antenna is wanted with the horizontal polarised antennas there must be a good attenuation of the back lobe. In addition to this the interfering radiator should be situated behind the antenna.

When a system does not demand the use of an omni-directional antenna it is recommended that directional antennas are used e.g. two-element yagis in permanent external installations. Please note that as antenna amplification increases the setting of the direction of the antenna requires more attention.

Base stations in high places should be supplied with high-Q cavity filters. Please note that the higher the base station antenna, the larger the coverage area and in turn that the risk of interference is also increased.

SATEL recommends the use of a band-pass filter with a large Q in the antenna cable of the base station.

Example of an antenna installation: by using amplifying antennas (G =Gain) and by installing the antenna high, long connection distances can be realised using the SATEL-EASy Pro+ radio modem.

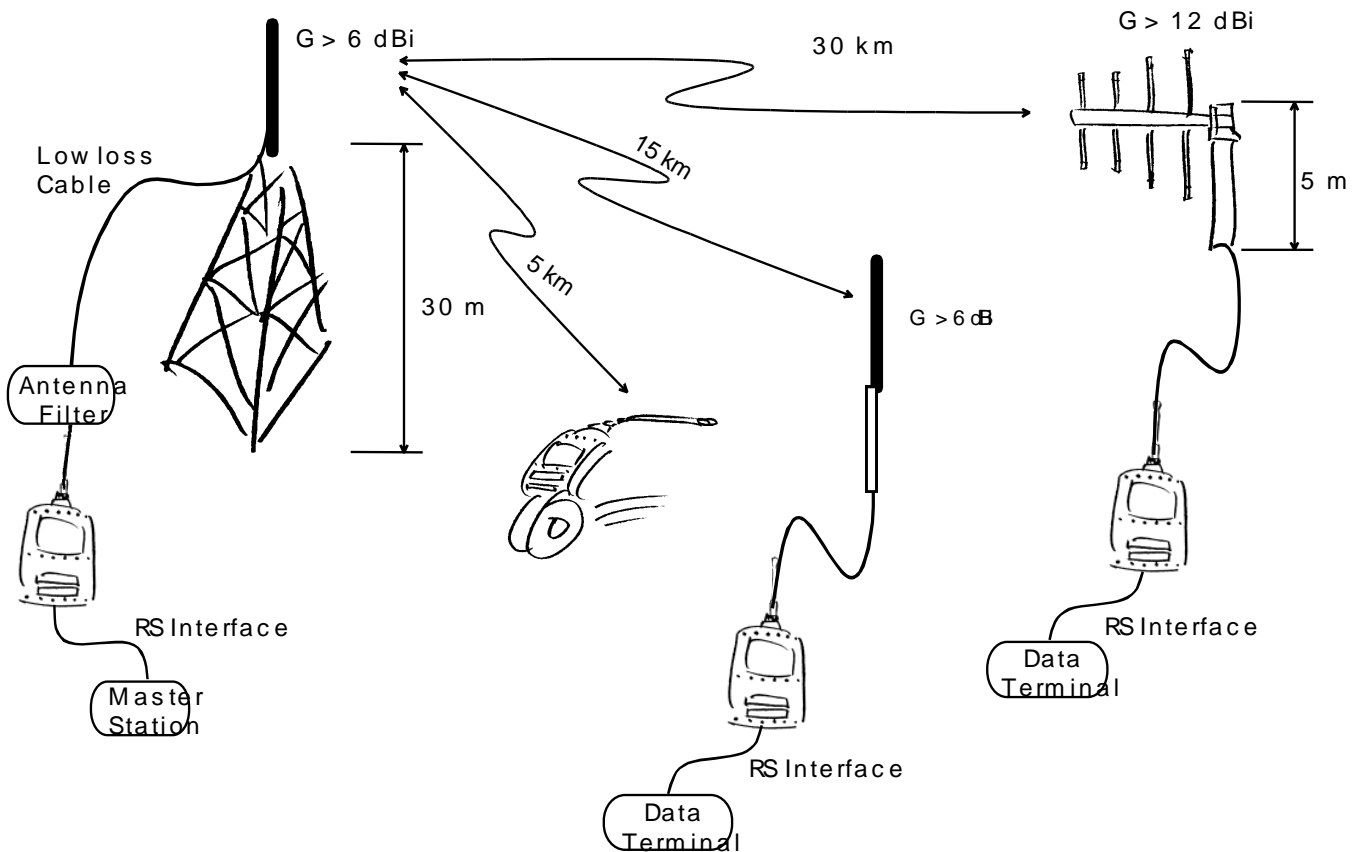

15.3 SATEL-EASy Pro+ grounding

SATEL-EASy Pro+ is equipped with a grounding terminal, as shown below. It is recommended to connect a ground wire from the grounding terminal to the earth ground and that all other interconnected devices share the same electrical ground point.



15.4 Grounding cable and screws

Grounding cable should be with $>1 \text{ mm}^2$ copper conductor with insulation, preferable green/yellow coded for easy ground recognition. Cable should be joined to grounding connector by crimp connection (pictured). Grounding should be terminated to a grounding rail or other reliable grounding source with shortest possible cable length to avoid ground loops and elevated resistances in cables. If longer cable is needed, cable thickness should be increased accordingly.

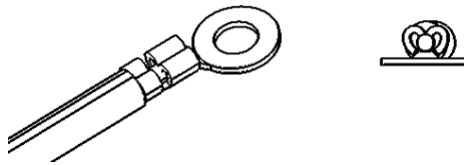

Screw type B (M4: Grounding screw, DIN 7985 TX20 M4X12) is used for grounding connector attachment.

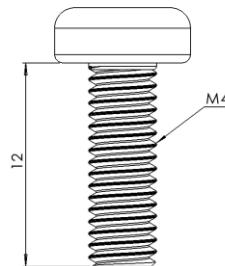

16. DESIGNING SYSTEMS

16.1 Factors affecting the quality and distance of the radio connection

- power of the radio transmitter
- sensitivity of the radio receiver
- tolerance of spurious radiations of the radio modulating signal
- amplification of transmitting and receiving antennas
- antenna cable attenuation
- antenna height
- natural obstacles
- interference caused by other electrical equipment

The transmitter power of the SATEL-EASy Pro+ is 35W (maximum) and the sensitivity of the receiver better than -110 dBm. Thus in a flat area and in free space with a 1/4 wave antenna (antenna amplification 1 dBi) and antenna height of 1m communication distances of 3 to 4km can be achieved. Distances may be considerably shorter in situations where there are metallic walls or other material inhibiting the propagation of radio waves.

Over long distances, increasing the height of antennas can often solve problems caused by natural obstacles. A ten-fold increase in distance can be achieved with the use of amplifying antennas. Frequent topographical variations over long distances may require that at least one of the antennas be raised to a height of 10 to 20 m.

If the antenna cable is more than 10 meters long, it is necessary to use a low loss cable (< 0.7 dB /10 m) in order not to waste the antenna amplification. Adding a repeater station can also solve problematical radio connections. In systems with many base stations the RSSI-signal can be used to assist in choosing the base station with the best signal. A communications network can also be built with a combination of cables and radio data modems.

The SATEL-EASy Pro+ operates in the 450 MHz band, where man made interference is insignificant. Long distance interference needs not to be taken into account even in special weather conditions.

The SATEL-EASy Pro+ tolerates normal levels of interference that occur. However, exceptionally high levels of interference can break through the safeguards and thus cause errors in data transfer. In mobile vehicle applications the range of operation can be increased by dividing the transmitted data into e.g. 50...500 byte long blocks and by re-transmitting the defected blocks.

A sufficient safety margin can be obtained by testing the communication path using extra 6 dB attenuation at the antenna connection and with slightly less effective antennas than those to be used in the final system.

16.2 Radio field strength

Radio signal strength must be good enough for successful data transfer. Where field strength is above a certain level, the operational results are very good. Below this level, a few dB marginal areas occur in which errors begin to be generated by noise and interference that will eventually lead to loss of connection.

The field strength is at its optimum level in open space, although increasing distance will still reduce it. It must also be remembered that one open space has different environmental and external factors to another, and that the effects on transmission quality must be taken into account when planning the system.

Ground, ground contours and buildings cause attenuation (loss of energy through absorption) and reflection of radio waves. Buildings reflect radio waves and therefore the effects of attenuation are not as acute when transmission is over a short distance.

However, the reflected waves will often be a bit delayed, and when they combine with the direct radio waves they interact in either a weakening or a strengthening way. This causes the fading effect in mobile systems. In reality very sharp signal drops spaced about 35 cm apart may occur. The attenuation may even reach 40 dB, normally less.

17. CHECK LIST

The following points must be taken into account when installing and configuring a radio modem:

1. All operating voltages of all the equipment concerned must always be switched OFF before connecting the serial interface cable.
2. When considering the exact placement of a radio modem and/or its antenna, the following points must be taken into account to guarantee optimal results:
 - The antenna should be installed in open space as far as possible from any possible sources of interference
 - The radio modem should not be installed onto a strongly vibrating surface
 - The radio modem should be installed in such a way as to minimise exposure to direct sunlight.
3. To ensure reliable operation the voltage output of the power supply used must be stable enough and the current capability of the power supply must be sufficient.
4. The antenna must be installed according to instructions.
5. *Serial interface settings between the radio modem and the terminal unit must correspond to each other.*
6. All radio modems in the same system must be configured using equal radio settings (radio frequency, channel spacing, compatibility, forward error correction and data field length).

18. ACCESSORIES

18.1 RS-232 cables and adapters

Product code	Type	Description
YC0368	CRS-35W 8-pin	8-pin ODU male / D9 female
YC0369	CRS-35W 8-/7-pin	8-pin ODU male / 7-pin male
YC0359	CRS-35W 8-/8-pin	8-pin ODU male / 8-pin male
YC0374	CRS-35W 8-/8-pin (0/30)	8-pin male (0 deg) / 8-pin male (30 deg)
YC0232	Data cable RS232 ODU to USB-A	1.8 m cable ODU 8-pin male / USB-A
YC0240	NARS-ST	8-pin ODU male / D15 female
YP1150	Power adapter 150W	ODU 2-pin male, C14 male IEC power inlet. IN, 100-240 Vac, OUT 12 Vdc / 12.5 A
YC0904	Mains cable C-M	With Europlug for YP1150

Contact SATEL Oy for more detailed information about other serial interface cable options.

18.2 Power cable

Product code	Type	Description
YC2957	C-P-Pro+ 2m	Power cable 2m, ODU 2-pin male / 4 mm lab plugs
YC1353	C-P-Pro+ 3m	Power cable 3m, ODU 2-pin male / Alligator clip

Contact SATEL Oy for more detailed information about other power cable options.

18.3 RF-cables

Product code	Type	Description	Length	Note
YC1101	CRF-1	Cable with TNC m / TNC f-connectors	1 m	RG58 (3 dB/10 m)
YC1105	CRF-5F	Cable with TNC m / TNC f-connectors	5 m	RG58 (3 dB/10 m)
YC1106	CRF-5M	Cable with TNC m / TNC m-connectors	5 m	RG58 (3 dB/10 m)
YC1004	ECOFLEX10	Low loss cable	X	0.9 dB / 10 m
YC1005	ECOFLEX15	Low loss cable	X	0.6 dB / 10 m

Note! In the description, m=male, f=female connector type.

18.4 Antennas

Type	Description
CA420O	Omnidirectional coaxial dipole, 2 dBi, 405-440 MHz
CA450O	Omnidirectional coaxial dipole, 2 dBi, 440-475 MHz
CA405GP+	Omnidirectional ground plane, 6 dBi, 401-409 MHz
CA410GP+	Omnidirectional ground plane, 6 dBi, 406-414 MHz
CA420GP+	Omnidirectional ground plane, 6 dBi, 416-424 MHz
CA430GP+	Omnidirectional ground plane, 6 dBi, 426-434 MHz
CA435GP+	Omnidirectional ground plane, 6 dBi, 431-439 MHz
CA440GP+	Omnidirectional ground plane, 6 dBi, 436-444 MHz
CA445GP+	Omnidirectional ground plane, 6 dBi, 441-449 MHz
CA450GP+	Omnidirectional ground plane, 6 dBi, 446-454 MHz
CA460GP+	Omnidirectional ground plane, 6 dBi, 456-464 MHz
CA470GP+	Omnidirectional ground plane, 6 dBi, 465-475 MHz
CA400Y	Directional yagi, 6 dBi, 380-410 MHz
CA420Y	Directional yagi, 6 dBi, 405-440 MHz
CA450Y	Directional yagi, 6 dBi, 440-475 MHz
CA400Y+	Directional yagi, 8 dBi, 380-410 MHz
CA420Y+	Directional yagi, 8 dBi, 405-440 MHz
CA450Y+	Directional yagi, 8 dBi, 440-475 MHz

SATEL antenna selection includes also directional and/or omni-directional antenna. These can be supplied separately on request.

18.5 Filters and lightning protectors

If a radio modem system is installed in an environment that contains high-power transmitters or sources of radio frequency interference, it is highly recommendable to insert suitable filters between each radio modem and its antenna. If a station is installed to a location exposed to lightning, it is recommended to insert a lightning protector to the feed-line outside the protected zone. SATEL Technical Support can give guidance in the selection of suitable products.

19. APPENDIX A

ASCII CHARACTER TABLE														
D	H	A	D	H	A	D	H	A	D	H	A	D	H	A
0	0	NUL	43	2B	+	86	56	V	129	81		172	AC	
1	1	SOH	44	2C	,	87	57	W	130	82		173	AD	
2	2	STX	45	2D	-	88	58	X	131	83		174	AE	
3	3	ETX	46	2E	.	89	59	Y	132	84		175	AF	
4	4	EOT	47	2F	/	90	5A	Z	133	85		176	B0	
5	5	ENQ	48	30	0	91	5B	[134	86		177	B1	
6	6	ACK	49	31	1	92	5C	\	135	87		178	B2	
7	7	BEL	50	32	2	93	5D]	136	88		179	B3	
8	8	BS	51	33	3	94	5E	^	137	89		180	B4	
9	9	HT	52	34	4	95	5F	_	138	8A		181	B5	
10	A	LF	53	35	5	96	60	`	139	8B		182	B6	
11	B	VT	54	36	6	97	61	a	140	8C		183	B7	
12	C	FF	55	37	7	98	62	b	141	8D		184	B8	
13	D	CR	56	38	8	99	63	c	142	8E		185	B9	
14	E	SO	57	39	9	100	64	d	143	8F		186	BA	
15	F	SI	58	3A	:	101	65	e	144	90		187	BB	
16	10	DLE	59	3B	;	102	66	f	145	91		188	BC	
17	11	DC1	60	3C	<	103	67	g	146	92		189	BD	
18	12	DC2	61	3D	=	104	68	h	147	93		190	BE	
19	13	DC3	62	3E	>	105	69	i	148	94		191	BF	
20	14	DC4	63	3F	?	106	6A	j	149	95		192	C0	
21	15	NAK	64	40	@	107	6B	k	150	96		193	C1	
22	16	SYN	65	41	A	108	6C	l	151	97		194	C2	
23	17	ETB	66	42	B	109	6D	m	152	98		195	C3	
24	18	CAN	67	43	C	110	6E	n	153	99		196	C4	
25	19	EM	68	44	D	111	6F	o	154	9A		197	C5	
26	1A	SUB	69	45	E	112	70	p	155	9B		198	C6	
27	1B	ESC	70	46	F	113	71	q	156	9C		199	C7	
28	1C	FS	71	47	G	114	72	r	157	9D		200	C8	
29	1D	GS	72	48	H	115	73	s	158	9E		201	C9	
30	1E	RS	73	49	I	116	74	t	159	9F		202	CA	
31	1F	US	74	4A	J	117	75	u	160	A0		203	CB	
32	20	SP	75	4B	K	118	76	v	161	A1		204	CC	
33	21	!	76	4C	L	119	77	w	162	A2		205	CD	
34	22	"	77	4D	M	120	78	x	163	A3		206	CE	
35	23	#	78	4E	N	121	79	y	164	A4		207	CF	
36	24	\$	79	4F	O	122	7A	z	165	A5		208	D0	
37	25	%	80	50	P	123	7B	{	166	A6		209	D1	
38	26	&	81	51	Q	124	7C		167	A7		210	D2	
39	27	'	82	52	R	125	7D	}	168	A8		211	D3	
40	28	(83	53	S	126	7E	~	169	A9		212	D4	
41	29)	84	54	T	127	7F		170	AA		213	D5	
42	2A	*	85	55	U	128	80		171	AB		214	D6	

20. APPENDIX B

20.1 Transmission related delays

Delay from the end of transmission to the end of reception on the serial interface:

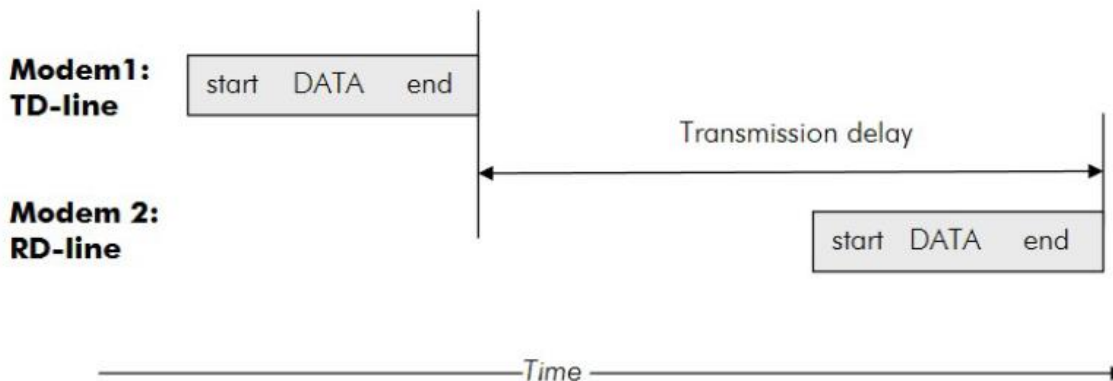

20.1.1 Transmission delays when the radio TX frequency is changed

- If the modem's transmitter frequency (TX) is different than the receiver frequency (RX), there has to be at least 20 ms delay from the Receive Data (RD) to Transmit Data (TD).
- If the transmitter frequency is changed by an SL-command, there has to be at least 20 ms delay after the SL-command before the Transmit Data.
- If the transmitter frequency is changed from TX1 to TX2 by an SL-command during the transmission, there has to be at least 20 ms delay after the SL-command before the Transmit Data.

20.1.2 Transmission delays when using a 12.5 kHz radio channel

Transmission delays without and with FEC-function (Forward Error Correction).

Delays are in milliseconds and with a 10% margin.

SATellite-3AS, 12.5 kHz, FEC OFF				
Number of bytes / Data rate/bps	1	10	100	500
9600	37	37	37	42
19200	36	39	71	203
38400	38	40	93	329
57600	36	41	102	372
115200	36	41	110	415

SATELLINE-3AS, 12.5 kHz, FEC ON				
Number of bytes Data rate/bps	1	10	100	500
9600	48	47	75	147
19200	47	46	110	367
38400	47	45	132	495
57600	46	46	140	538
115200	46	46	148	580

SATEL-8FSK-1, 12.5 kHz, FEC OFF				
Number of bytes Data rate/bps	1	10	100	500
9600	37	36	36	70
19200	36	36	43	68
38400	36	38	65	188
57600	36	38	74	232
115200	36	39	82	274

SATEL-8FSK-2, 12.5 kHz, FEC ON				
Number of bytes Data rate/bps	1	10	100	500
9600	43	45	51	99
19200	43	48	79	225
38400	42	50	102	351
57600	42	51	109	394
115200	42	51	117	436

SATEL-16FSK-1, 12.5 kHz, FEC ON				
Number of bytes Data rate/bps	1	10	100	500
9600	40	39	45	87
19200	39	41	52	99
38400	39	43	72	208
57600	39	44	79	251
115200	39	45	87	293

20.1.3 Transmission delays using a 25 kHz radio channel

Transmission delays without and with FEC-function (Forward Error Correction).

Delays are in milliseconds and with a 10% margin.

SATELLINE-3AS, 25 kHz, FEC OFF				
Number of bytes Data rate/bps	1	10	100	500
9600	22	22	22	42
19200	22	22	22	28
38400	21	23	38	103
57600	21	23	46	147
115200	21	24	54	190

SATELLINE-3AS, 25 kHz, FEC ON				
Number of bytes Data rate/bps	1	10	100	500
9600	29	28	29	58
19200	28	27	38	78
38400	28	27	58	187
57600	27	27	66	230
115200	27	27	74	273

SATEL-8FSK-1, 25 kHz, FEC OFF				
Number of bytes Data rate/bps	1	10	100	500
9600	20	20	25	69
19200	18	19	19	36
38400	19	19	23	35
57600	19	20	30	74
115200	19	20	38	117

SATEL-8FSK-2, 25 kHz, FEC ON				
Number of bytes Data rate/bps	1	10	100	500
9600	24	23	29	51
19200	23	24	28	51
38400	23	26	44	114
57600	23	26	49	156
115200	23	27	56	199

SATEL-16FSK-1, 25 kHz, FEC ON				
Number of bytes Data rate/bps	1	10	100	500
9600	22	22	27	60
19200	22	21	25	52
38400	21	22	28	63
57600	21	23	34	85
115200	21	24	41	127

21. APPENDIX C

21.1 Dimensions, SATEL-EASy Pro+

The device physical dimensions and the holes in millimetres. The dimensions of 1- and 2-serial port versions are the same.

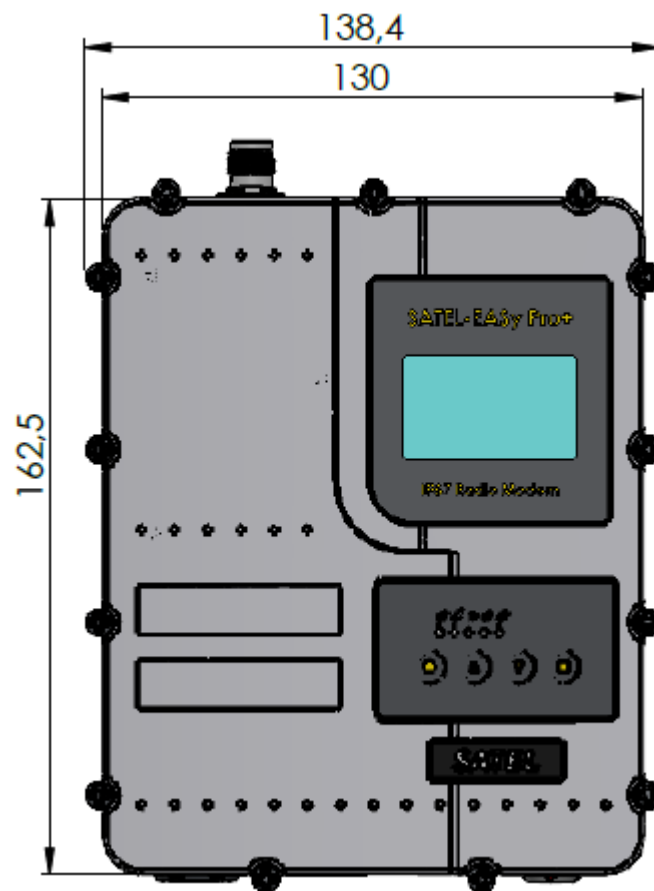

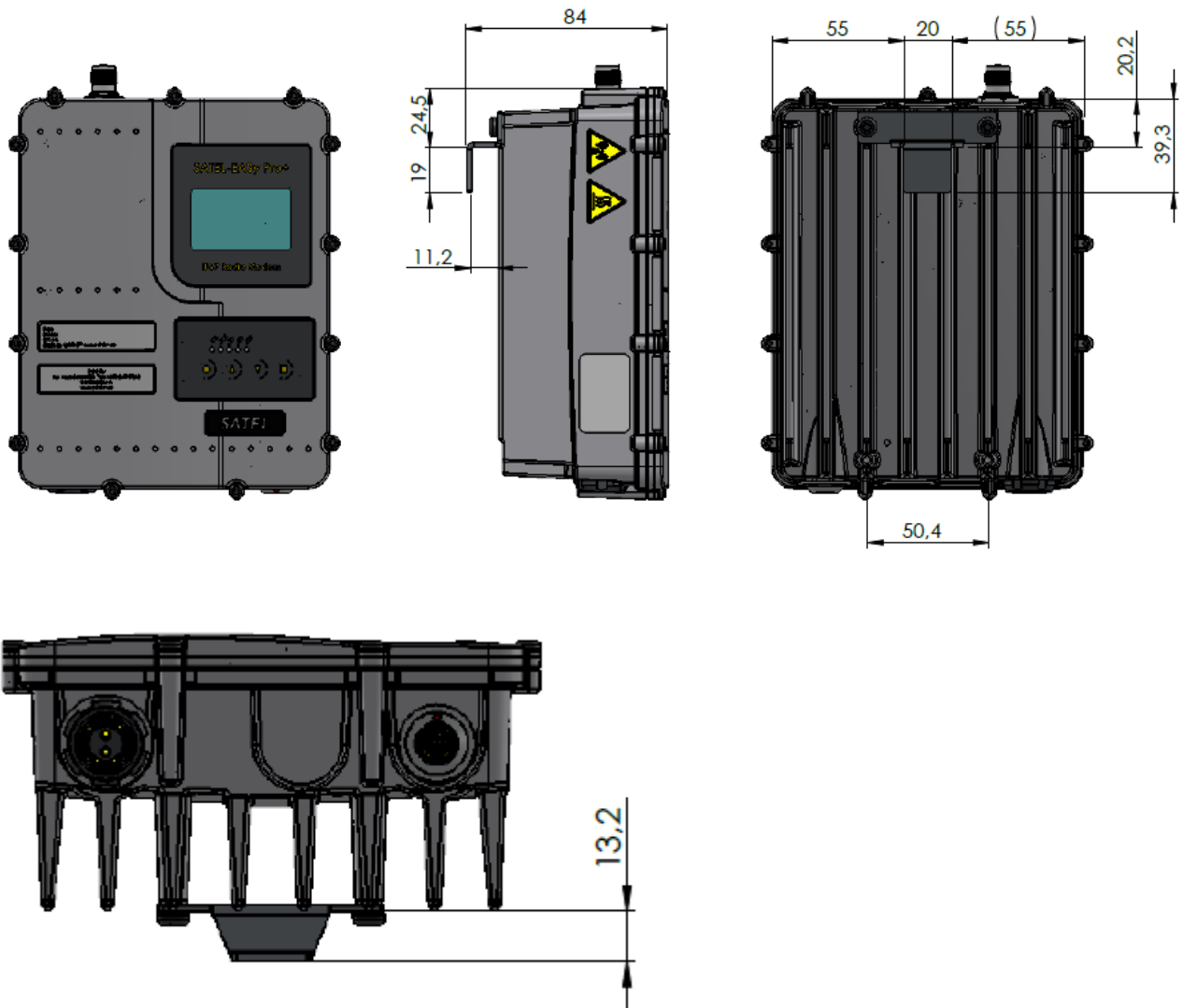

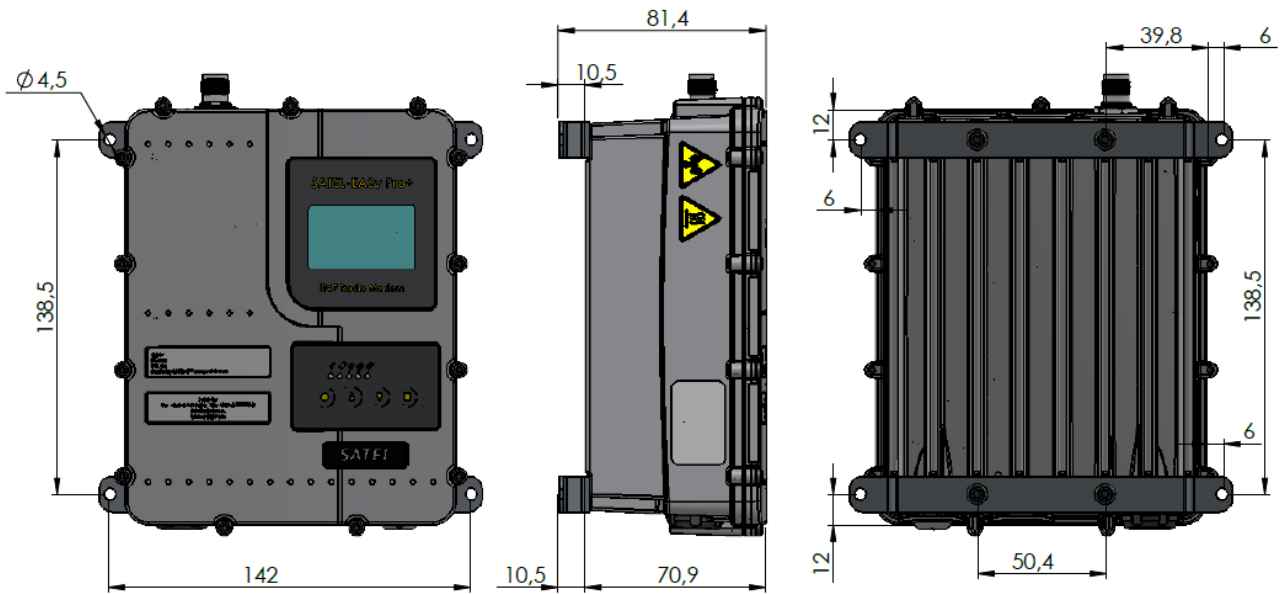

1-serial port model

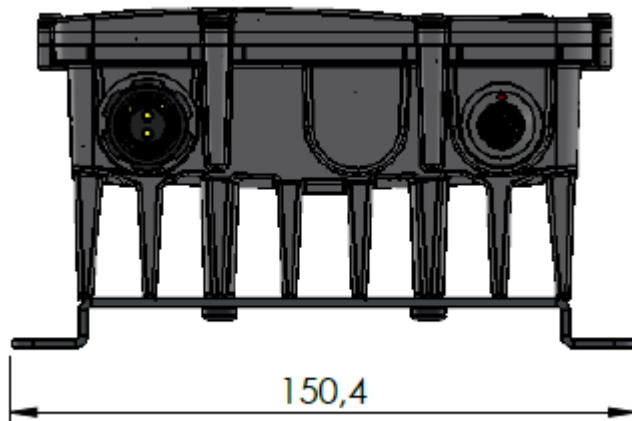

2-serial port model

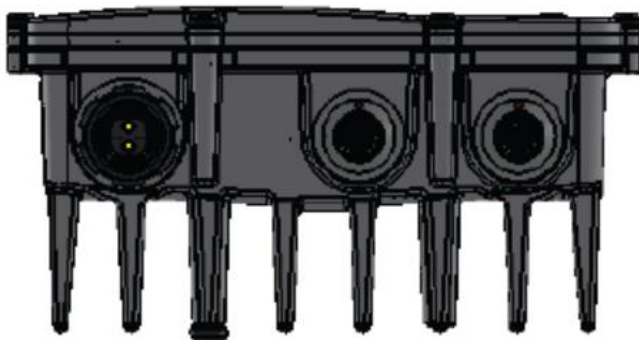

The device physical dimensions and the holes in millimetres with wall mount parts (WP0135).

22. VERSION HISTORY

Version history:

Version:	Date:	Remarks:
1.0	11.07.2022	First official version
1.1	11.08.2022	Added information of grounding, chapters 13.3 and 13.4
1.2	8.11.2022	FCC regulatory information added, grounding screw type corrected.
1.3	28.11.2022	Safety distance table updated
1.4	01.02.2023	Chapter 4.2.1 updated, chapter 4.2.2 added
1.5	01.03.2023	Chapters 6.9.1 and 6.9.2 updated
1.6	17.10.2023	2-serial port features added
1.7	2.01.2025	RTCM "SC135" radio protocol additions. Multiple minor changes.